

SLO 24TR

SL-series plug-in output relay, 1 NO 3A (90A/20ms)/240 VAC

Typically used

- Interface relay between PLC and field apparatus
- Capable of switching both resistive and inductive AC-loads
- Control of pumps, solenoids, fans, contactors etc.

Main features

- 10-year warranty
- MTTF (MIL-HDBK-217F) 422 years
- cULus Listed, CE (EMC and LVD)
- Integrated status LED



Functional block diagram

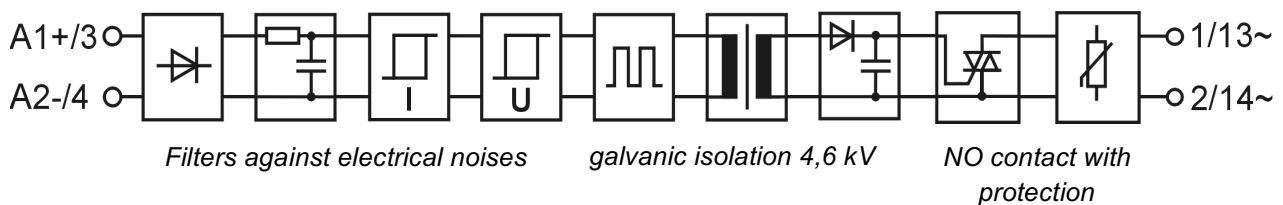

Main specifications

Breakdown voltage I/O	minimum	4600	VAC rms
Air/creepage distances I/O	minimum	8	mm
Capacitance I/O	typical	3	pF
Material of the casing	PBT	UL 94V-0	
Colour of the casing		Black	
Weight	typical	40	g
Temperature range:			
Storage	range	-40...+70	°C
Operation	range	-10...+70	°C

Electrical specifications ($T_A = 25\text{ °C}$)

Primary				Secondary			
Input voltage	nominal	24	VDC	Load voltage	minimum	0	VAC
Input current at nominal voltage	typical	15	mA		nominal	240	VAC
	maximum	17	mA		maximum	265	VAC
Input voltage range (abs.)	minimum	18	VDC	Load current	maximum	3	A
	maximum	32	VDC	Load current	maximum	90	A (20 ms)
Input impedance	typical	1,4	kΩ	Voltage drop	typical	1	V
Switch-on voltage *	typical	16	VDC	Switch-on delay	typical	0,5	ms
	maximum	18	VDC		maximum	1	ms
Switch-off voltage	typical	14	VDC	Switch-off delay	typical	-	ms
	minimum	12	VDC		maximum	11	ms
				Load power factor, $\cos \Phi$		0...1	
				dv/dt, off-state	typical	4000	V/μs
				Leakage current (off-state)	typical	50	μA

Ambient temperature (T_A) means the temperature immediate in vicinity of relays, where the air flow meets the relays.

* In the operational temperature range -10 °C...+70 °C the switch-on voltage is 20,4 VDC maximum (24 VDC -15 %).

Deratings

Allowed load is derated to 1/3 linearly from +30 °C to +70 °C ambient temperature. When relays are mounted together as a bank the maximum load current for long period of time should be restricted in total to 50 % of the current from the curve. I.e. all relays at 50 % load continuously or 50 % of the relays at 100 % load continuously or all relays at 100 % load 50 % of the time. This restriction does not apply if there is at least 12,5 mm gap between relays. These deratings apply when assembled to the horizontal rail. If assembled to the vertical rail, must be taken care that the relays do not heat up too much.

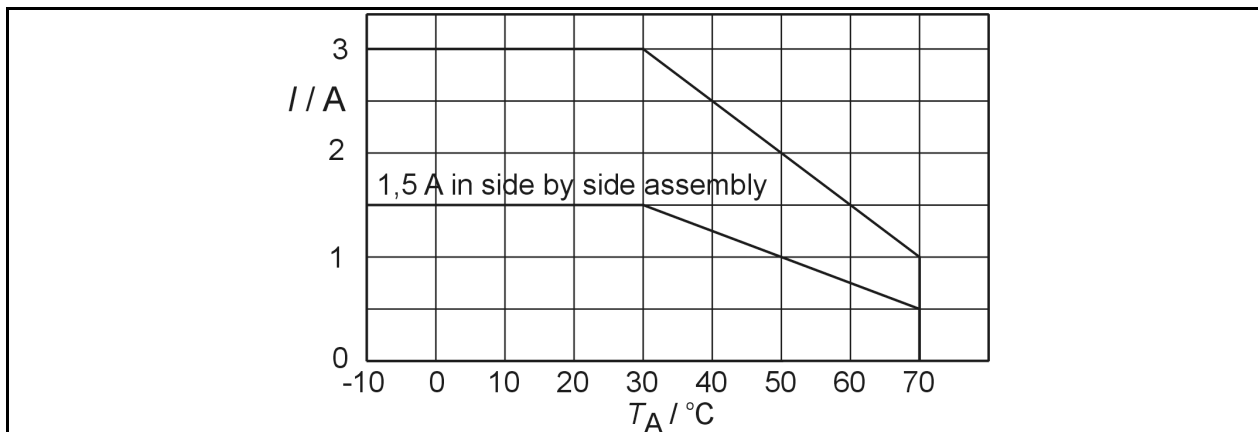

Derating curve for SLO 24TR.

Derating when switching inductive loads

There is no need to derate solid state output relay using a triac switch. The relay is indifferent to the power factor of the load. Calculation should be made however that the surge current does not exceed the specification. For reasons of heat dissipation, when the load will be switched frequently, the average current over a reasonable time should not exceed the specification for continuous operation.

Fusing

To protect relay against short circuit and overload a fast fuse with the correct rating for the load and the capacity of the relay should be chosen. Note that when overload current is not large it is possible that the fuse will not protect the relay because of the tolerance on the fuse rating.

Assembling

All MOS 1... -mounting sockets, all MB/MBS 8/16... -mounting bases. The recommended installation is to the horizontal rail for better cooling of the relays.

Mechanical dimensions

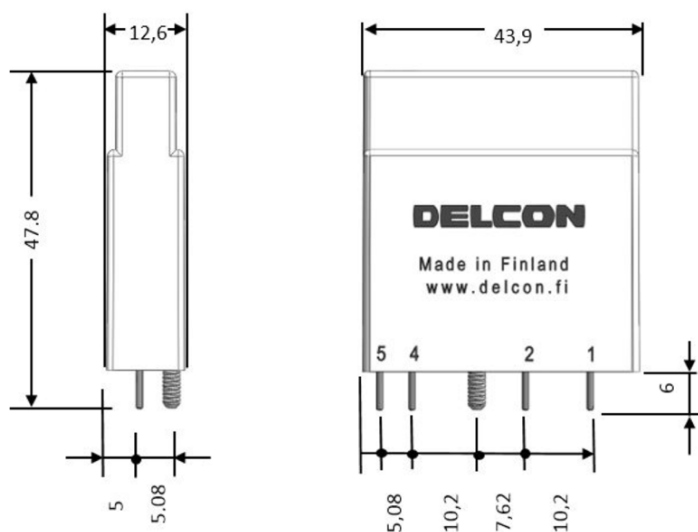

SLO xxx -relay (plug-in), dimensions in mm, nominal.

Related products for SLOxxx relays

DIN-rail sockets for single relays

MOS 1GN screw terminals
MOS 1CCN spring terminals



Jumper bars for cross-connecting relays in parallel

JUMPER 8-13 Chaining Jumper for 8 relays
JUMPER 16-13 Chaining Jumper for 16 relays

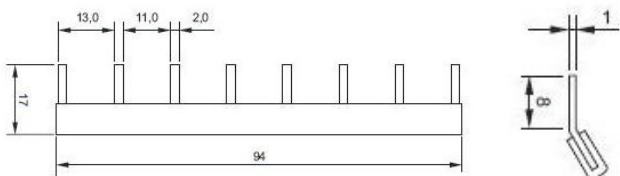

DIN-rail mounting bases with easy PLC connection

MBS 8BIOP for 8 relays, screw terminals
MBS 8BIOPCC for 8 relays, spring terminals



RC10X-xxx

applicable 10-pole round cable (xxx = length / cm, in 50 cm steps)
 Connection to PLC with colour coded single wires with ferrules

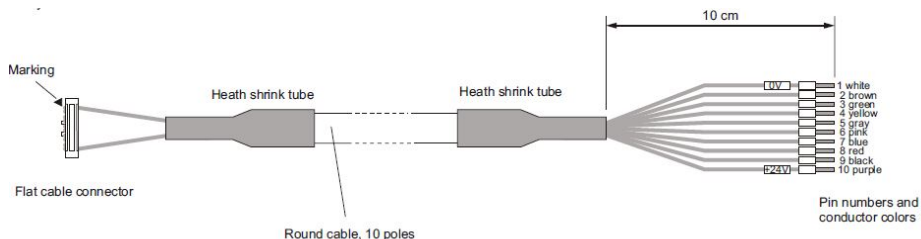

MBS 16BIOP
MBS 16BIOPCC

for 16 relays, screw terminals
for 16 relays, spring terminals



RC20X-xxx

applicable 20-pole round cable (xxx = length/cm, in 50 cm steps)
Connection to PLC with colour coded single wires with ferrules

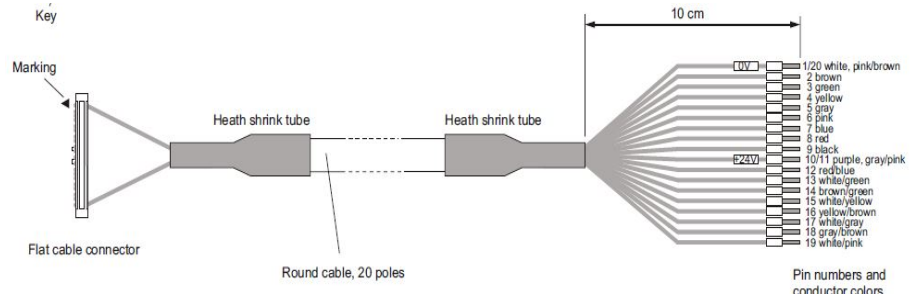

PCB sockets

PC0 1N





Installed pin connectors:
4 3 2 1

PCU 1N



Installed pin connectors:
5 4 3 2 1

Approvals

 <p>US LISTED 3HMB IND. CONT. EQ.</p>	<p>Certificate: E162828</p>
	<p>Fulfils main requirements of the EMC-directive 2004/108/EC. The relay has been designed to operate correctly with difficult loads in disturbed environments. Thus it does not meet the conducted emission for 150 kHz...2 MHz.</p> <p>Fulfils requirements of the low voltage directive (LVD) 2006/95/EC.</p>

Guarantee

This solid state I/O relay type made by Delcon Oy is guaranteed free from design and manufacturing defects for a period of 10 years from the manufacturing date. The guarantee liability is limited to replacement of defective material and related shipping charges. Defective products must be returned to the manufacturer for evaluation. This guarantee does not cover damage due to incorrect use or electrical overload.