

safeVisionary2

Safety camera sensor

SICK
Sensor Intelligence.



Described product

safeVisionary2

Manufacturer

SICK AG
Erwin-Sick-Str. 1
79183 Waldkirch
Germany

Legal information

This work is protected by copyright. Any rights derived from the copyright shall be reserved for SICK AG. Reproduction of this document or parts of this document is only permissible within the limits of the legal determination of Copyright Law. Any modification, abridgment or translation of this document is prohibited without the express written permission of SICK AG.

The trademarks stated in this document are the property of their respective owner.

© SICK AG. All rights reserved.

Original document

This document is an original document of SICK AG.



Contents

1	About this document.....	7
1.1	Scope.....	7
1.2	Target groups of these operating instructions.....	7
1.3	Further information.....	7
1.4	Symbols and document conventions.....	7
2	Safety information.....	9
2.1	General safety notes.....	9
2.2	Intended use.....	10
2.3	Inappropriate use.....	10
2.4	Cybersecurity.....	10
2.5	Requirements for the qualification of personnel.....	11
3	Product description.....	12
3.1	Device overview.....	12
3.2	Structure and function.....	12
3.3	Status indicators.....	14
3.4	Product characteristics.....	14
3.4.1	Coordinate system.....	14
3.4.2	Field types.....	16
3.5	Example applications.....	18
4	Project planning.....	22
4.1	Manufacturer of the machine.....	22
4.2	Operating entity of the machine.....	22
4.3	Design.....	22
4.3.1	Planning for mounting.....	22
4.3.2	Planning of the protective field.....	24
4.3.3	Timing for monitoring case switching.....	26
4.3.4	Approach direction.....	27
4.3.5	Minimum distance for stationary applications.....	28
4.3.6	Hazardous area protection.....	28
4.3.7	Hazardous point protection.....	30
4.3.8	Access protection.....	32
4.3.9	Mobile hazardous area protection.....	34
4.3.10	Fall protection.....	36
4.4	Integration in the electrical control system.....	38
4.4.1	Electromagnetic compatibility.....	38
4.4.2	Voltage supply.....	39
4.4.3	OSSDs.....	39
4.4.4	Control inputs.....	40
4.4.5	Universal inputs, universal outputs, universal I/Os.....	43
4.4.6	Restart interlock.....	43
4.4.7	External device monitoring (EDM).....	43

4.5	Integration into the network.....	44
4.5.1	Network topology.....	44
4.5.2	Network services and ports.....	44
4.6	Testing plan.....	44
4.6.1	Planning the thorough check during commissioning and in certain situations.....	45
4.6.2	Planning the regular thorough check.....	46
4.6.3	Notes on the tests.....	46
5	Mounting.....	50
5.1	Mounting the heat sink.....	50
5.2	Mounting the device.....	50
6	Electrical installation.....	52
6.1	System connection.....	52
6.2	Ethernet connection.....	53
7	Configuration.....	54
7.1	Delivery state.....	54
7.2	Safety Designer configuration software.....	54
7.2.1	Installing Safety Designer.....	54
7.2.2	Creating a project.....	54
7.2.3	User interface.....	55
7.2.4	Configuring devices online.....	55
7.2.5	Configuring devices offline.....	56
7.2.6	User groups.....	56
7.3	Add device tile.....	57
7.4	Open the device window – configure devices.....	57
7.5	Overview.....	58
7.6	Network settings.....	59
7.6.1	Ethernet.....	59
7.7	Reading configuration.....	59
7.8	Identification.....	59
7.9	Monitoring settings.....	60
7.10	3D editor.....	62
7.10.1	Adjusting the mounting settings.....	64
7.10.2	Calibration data and Contours.....	65
7.10.3	Fields and ROI.....	66
7.11	Inputs and outputs, local.....	69
7.11.1	Output signals.....	70
7.11.2	Input signals.....	71
7.11.3	Further settings for some signals.....	72
7.12	Monitoring cases.....	73
7.12.1	Settings for monitoring case tables.....	73
7.12.2	Settings for monitoring cases.....	74
7.12.3	Defining input conditions.....	74

7.12.4	Configuring cut-off paths.....	74
7.12.5	Assigning field sets and ROI sets.....	75
7.12.6	Assigning a defined cut-off behavior.....	75
7.13	Data output.....	76
7.14	Transferring a configuration.....	76
7.15	Verify configuration.....	77
7.16	Starting and stopping safety function.....	78
7.17	Report.....	78
7.18	Service.....	79
7.18.1	Assigning or changing passwords.....	79
7.18.2	Resetting the password.....	79
8	Commissioning.....	81
8.1	Switching on.....	81
8.2	Check during commissioning and modifications.....	81
9	Operation.....	82
9.1	Status indicators.....	82
10	Maintenance.....	84
10.1	Cleaning the product.....	84
10.2	Regular thorough check.....	84
11	Troubleshooting.....	85
11.1	Fault indicators.....	85
11.2	Diagnostics using Safety Designer.....	85
11.2.1	Data recorder.....	86
11.2.2	Event history.....	87
11.2.3	Message history.....	88
12	Decommissioning.....	91
12.1	Disposal.....	91
13	Technical data.....	92
13.1	Data sheet.....	92
13.2	Response time.....	95
13.3	Course of the OSSD test over time.....	96
13.4	Scanning range.....	97
13.5	Dimensional drawings.....	99
14	Ordering information.....	101
14.1	Scope of delivery.....	101
14.2	Ordering information for the safety camera sensor.....	101
15	Accessories.....	102
15.1	Accessories.....	102
16	Glossary.....	103

17	Annex.....	106
17.1	Conformities and certificates.....	106
17.1.1	EU declaration of conformity.....	106
17.2	Note on standards.....	106
17.3	Licenses.....	107
17.4	Checklist for initial commissioning and commissioning.....	108
18	List of figures.....	109
19	List of tables.....	110

1 About this document

1.1 Scope

Product

This document applies to the following products:

- Product code: safeVisionary2
- "Operating instructions" type label entry: 8025917

Document identification

Document part number:

- This document: 8025919
- Available language versions of this document: 8025917

You can find the current version of all documents at www.sick.com.

1.2 Target groups of these operating instructions

Some sections of these operating instructions are intended for certain target groups. However, the entire operating instructions are relevant for intended use of the product.

Table 1: Target groups and selected sections of these operating instructions

Target group	Sections of these operating instructions
Project developers (planners, developers, designers)	"Project planning", page 22 "Configuration", page 54 "Technical data", page 92 "Accessories", page 102
Installers	"Mounting", page 50
Electricians	"Electrical installation", page 52
Safety experts (such as CE authorized representatives, compliance officers, people who test and approve the application)	"Project planning", page 22 "Configuration", page 54 "Commissioning", page 81 "Technical data", page 92 "Checklist for initial commissioning and commissioning", page 108
Operators	"Operation", page 82 "Troubleshooting", page 85
Maintenance personnel	"Maintenance", page 84 "Troubleshooting", page 85

1.3 Further information

www.sick.com

The following information is available via the Internet:

- Data sheets and application examples
- CAD files and dimensional drawings
- Certificates (such as the EU declaration of conformity)
- Guide for Safe Machinery. Six steps to a safe machine
- Safety Designer (software for configuring safety solutions made by SICK AG)

1.4 Symbols and document conventions

The following symbols and conventions are used in this document:

Safety notes and other notes



DANGER

Indicates a situation presenting imminent danger, which will lead to death or serious injuries if not prevented.



WARNING

Indicates a situation presenting possible danger, which may lead to death or serious injuries if not prevented.



CAUTION

Indicates a situation presenting possible danger, which may lead to moderate or minor injuries if not prevented.



NOTICE

Indicates a situation presenting possible danger, which may lead to property damage if not prevented.



NOTE

Indicates useful tips and recommendations.

Instructions to action

- ▶ The arrow denotes instructions to action.
- 1. The sequence of instructions for action is numbered.
- 2. Follow the order in which the numbered instructions are given.
- ✓ The check mark denotes the result of an instruction.

LED symbols

These symbols indicate the status of an LED:

- The LED is off.
- ◐ The LED is flashing.
- The LED is illuminated continuously.

2 Safety information

2.1 General safety notes

Product integration



DANGER

The product can not offer the expected protection if it is integrated incorrectly.

- ▶ Plan the integration of the product in accordance with the machine requirements (project planning).
- ▶ Implement the integration of the product in accordance with the project planning.

Laser class 1



CAUTION

If any operating or adjusting devices other than those specified in this document are used or other methods are employed, this can lead to dangerous exposure to radiation.

- ▶ Only use the operating or adjusting devices specified in this document.
- ▶ Only follow the methods specified in this document.
- ▶ Do not open the housing, except for the purposes of the installation and maintenance work specified in these operating instructions.

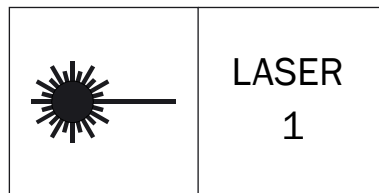

Figure 1: Laser class 1

This device complies with the following standards:

- IEC 60825-1:2014
- 21 CFR 1040.10 and 1040.11, except compliance with IEC 60825-1:2014, as described in Laser Notice No. 56 dated May 8, 2019

The laser is eye-safe.

Mounting and electrical installation



DANGER

Death or severe injury due to electrical voltage and/or an unexpected startup of the machine

- ▶ Make sure that the machine is (and remains) disconnected from the voltage supply during mounting and electrical installation.
- ▶ Make sure that the dangerous state of the machine is and remains switched off.

Repairs and modifications



DANGER

Improper work on the product

A modified product may not offer the expected protection if it is integrated incorrectly.

- ▶ Apart from the procedures described in this document, do not repair, open, manipulate or otherwise modify the product.
-

2.2 Intended use

The safety camera sensor is an electro-sensitive protective equipment (ESPE) and is suitable for the following applications:

- Hazardous point protection
- Hazardous area protection
- Mobile hazardous area protection
- Access protection
- Fall protection for mobile applications

The product may be used in safety functions.

The product may be used in industrial environments. An industrial environment is an area that is not open to the public and where only adult, instructed persons are present.

The product must only be used within the limits of the prescribed and specified technical specifications and operating conditions at all times.

Incorrect use, improper modification or manipulation of the product will invalidate any warranty from SICK; in addition, any responsibility and liability of SICK for damage and secondary damage caused by this is excluded.

2.3 Inappropriate use

The safety camera sensor works as an indirect protective measure and cannot provide protection from ejected parts or from emitted radiation. Transparent objects are not detected.

The safety camera sensor is not suitable for the following applications, among others:

- Outdoors
- Underwater
- In explosion-hazardous areas

2.4 Cybersecurity

Overview

To protect against cybersecurity threats, it is necessary to continuously monitor and maintain a comprehensive cybersecurity concept. A suitable concept consists of organizational, technical, procedural, electronic, and physical levels of defense and considers suitable measures for different types of risks. The measures implemented in this product can only support protection against cybersecurity threats if the product is used as part of such a concept.

You will find further information at www.sick.com/psirt, e.g.:

- General information on cybersecurity
- Contact option for reporting vulnerabilities
- Information on known vulnerabilities (security advisories)

2.5 Requirements for the qualification of personnel

The product must be configured, installed, connected, commissioned, and serviced by qualified safety personnel only.

Project planning

You need safety expertise to implement safety functions and select suitable products for that purpose. You need expert knowledge of the applicable standards and regulations.

Mounting, electrical installation and commissioning

You need suitable expertise and experience. You must be able to assess if the machine is operating safely.

Configuration

You need suitable expertise and experience. You must be able to assess if the machine is operating safely.

Operation and maintenance

You need suitable expertise and experience. You must be instructed in machine operation by the machine operator. For maintenance, you must be able to assess if the machine is operating safely.

3 Product description

3.1 Device overview

Device overview

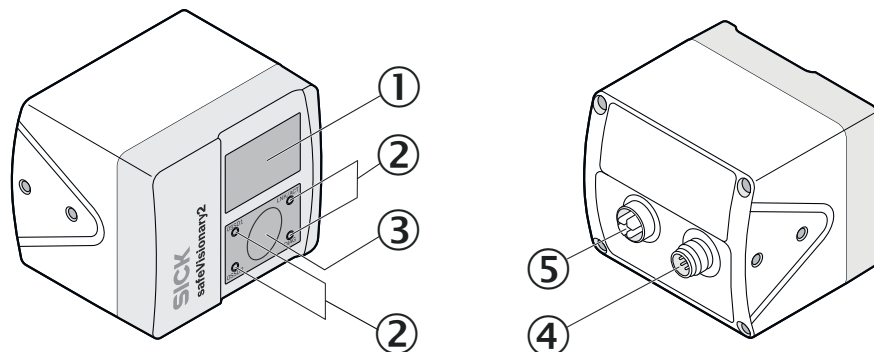

Figure 2: Device overview

- ① Illumination unit
- ② Status indicators: Status LEDs
- ③ Camera module
- ④ System connection: Voltage supply, OSSDs and universal IO
- ⑤ Ethernet connection

Further topics

- ["Electrical installation", page 52](#)
- ["Mounting", page 50](#)

3.2 Structure and function

Structure and function

The safety camera sensor is an electro-sensitive protective device (ESPE) which scans its surroundings three-dimensionally using infrared laser beams.

As soon as an object is situated in the protective field, the camera sensor signals the detection by means of a signal change at the safety output. The machine or its controller must safely analyze the signals (for example using a safety controller or a safety relay) and stop the dangerous state.

The camera sensor operates according to the optical time-of-flight measurement principle. It emits light pulses at regular, very short intervals. If the light strikes an object, it is reflected. The camera sensor receives the reflected light. The camera sensor calculates the distance to the object based on the time interval between the moment of transmission and moment of receipt (Δt).

Field of view

The camera sensor has a field of view with an aperture angle of $68^\circ \times 58^\circ$ (horizontal \times vertical).

For protective field evaluation, the field of view of the camera sensor is limited to $68^\circ \times 42^\circ$. The full $68^\circ \times 58^\circ$ field of view is available for all other safety functions, field types, and for data output.

Detection zones of different sizes are created depending on distance z .

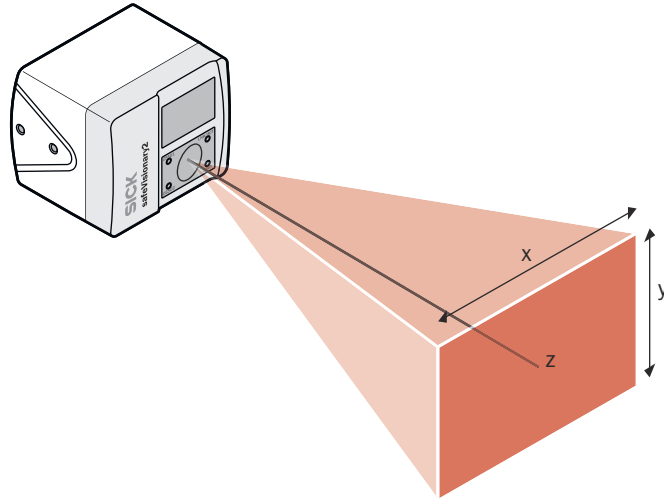

Figure 3: Size of the detection zone

Table 2: Size of the detection zone

Distance z	Field of view 68° × 58°		Limited field of view (protective field) 68° × 42°	
	Size x	Size y	Size x	Size y
0.2 m	0.27 m	0.22 m	0.27 m	0.15 m
0.5 m	0.68 m	0.56 m	0.68 m	0.39 m
1.0 m	1.35 m	1.11 m	1.35 m	0.77 m
1.5 m	2.03 m	1.67 m	2.03 m	1.14 m
2.0 m	2.7 m	2.22 m	2.7 m	1.51 m
4.0 m	5.4 m	4.44 m	5.4 m	3.02 m

Optical axis

The optical axis is perpendicular to the front screen of the camera module (see figure 3, page 13, z-axis).

Resolution

The object resolution indicates the minimum size that an object must be to allow it to be detected safely.

The resolution can be set to various values to suit the intended purpose.

Further topics

- "Planning for mounting", page 22

3.3 Status indicators

Status indicators

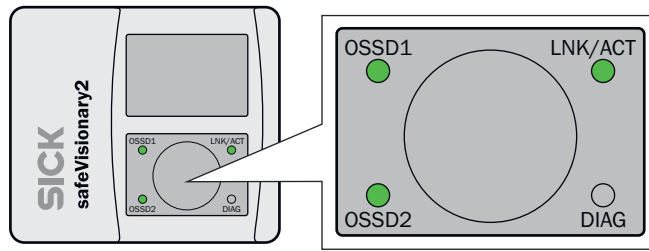

Figure 4: Status indicators

Table 3: Status indicators

LEDs	Color	Function
OSSD1	Green/yellow/red	OSSD pair 1 status
OSSD2	Green/yellow/red	OSSD pair 2 status
LNK/ACT	Yellow/green	Ethernet status
DIAG	Green/yellow/red	Diagnostics status Warning field status

Further topics

- ["Status indicators", page 82](#)
- ["Fault indicators", page 85](#)

3.4 Product characteristics

3.4.1 Coordinate system

Origin of the device coordinate system

The coordinate origin of the device coordinate system is at the point where the optical axis and the camera front screen (outer surface) intersect.

The Z axis runs along the optical axis. Looking in the direction of the optical axis, the X-axis points to the left and the Y-axis points upwards.

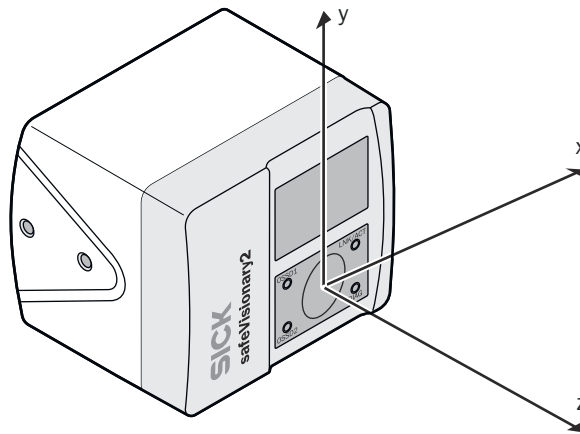

Figure 5: Origin of the device coordinate system

Device coordinates and world coordinates

	<p>Device coordinate system The device coordinates specify the position of an object relative to the sensor.</p>
	<p>World coordinate system The world coordinates specify the position of an object relative to the world (e.g., machine surroundings).</p>

You set the position and orientation of the safety camera sensor relative to the world coordinate system using the Safety Designer.

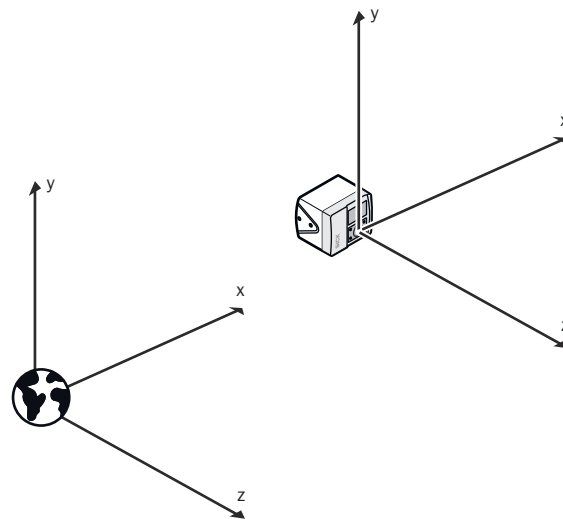

Figure 6: Device coordinate system in the world coordinate system

Further topics

- ["Dimensional drawings", page 99](#)
- ["Adjusting the mounting settings", page 64](#)

3.4.2 Field types

Overview

A safety camera sensor continuously checks whether people or objects are present in one or more areas. The areas to be checked are called fields. A distinction is made between the field types below, depending on the application type.

Protective field

Table 4: Protective field

Purpose	Detection and protection of people
Safe switch off (according to ISO 13849-1)	Yes
Safety-related parameters	PL c (ISO 13849-1), SIL 1 (IEC 61508)
Maximum scanning range (Z axis)	2 m 4 m in Increased scanning range mode
Field size	Configurable via the configuration software.
Field of view	68° × 42°
Description	The protective field is the area in which the test object specified by the manufacturer is detected by the electro-sensitive protective equipment (ESPE). As soon as the electro-sensitive protective device detects an object in the protective field, it switches the associated safety outputs to the OFF state. This signal can be passed to controllers resulting in the dangerous state coming to an end, e.g. to stop the machine or the vehicle.

Contour detection field

Table 5: Contour detection field

Purpose	Fall protection	Detection and protection of people in stationary applications
Safe switch off (according to ISO 13849-1)	Yes	
Safety-related parameters	PL c (ISO 13849-1), SIL 1 (IEC 61508)	
Maximum scanning range (Z axis)	2 m 4 m in Increased scanning range mode	2 m 4 m in Increased scanning range mode
Field size	Configurable via the configuration software.	
Field of view	68° × 58°	

Purpose	Fall protection	Detection and protection of people in stationary applications
Description	The contour detection field can, for example, protect AGVs from falling. The contour detection field monitors a contour of the environment. The electro-sensitive protective device switches the associated safety outputs to the OFF state if a contour does not correspond to the set specifications, e.g. because a door or flap is open.	The contour detection field can detect and protect people in stationary applications using a taught-in reference background. The contour detection field monitors a contour of the environment. The electro-sensitive protective device switches the associated safety outputs to the OFF state if a contour does not correspond to the configured requirements, e.g., because a person is present in the contour detection field. The person is obscuring the taught-in reference background.

In stationary applications, the contour detection field can be used to detect contamination on the front screens of the device.

Region of interest (ROI)

Table 6: Region of interest (ROI)

Purpose	Measurement data output	Safe distance check
Safe switch off (according to ISO 13849-1)	No	Yes
Safety-related parameters	-	PL c (ISO 13849-1), SIL 1 (IEC 61508)
Maximum scanning range (Z axis)	4 m	
Field size	10 pixels × 10 pixels	
Field of view	68° × 58°	
Description	The ROI determines distance values and checks them for plausibility.	
	The ROI function can transmit absolute distance values and quality information via the measurement data output.	The ROI function can monitor deviations from a specified distance value. In the event of a deviation, the associated safety outputs switch to the OFF state.

Warning field

Table 7: Warning field

Purpose	Use for automation purposes
Safe switch off (according to ISO 13849-1)	No
Safety-related parameters	-
Maximum scanning range (Z axis)	7.3 m
Field size	Configurable via the configuration software.
Field of view	68° × 58°

Purpose	Use for automation purposes
Description	The warning field monitors larger areas than the protective field. Simple switching functions can be triggered with the warning field, e.g. a warning light or an acoustic signal can be triggered if a person approaches, even before the person enters the protective field.

Further topics

- ["Scanning range", page 97](#)
- ["Fields", page 66](#)
- ["ROIs \(region of interest\)", page 69](#)

3.5 Example applications

Hazardous point protection

In hazardous point protection, the approach is detected very close to the hazardous point.

The advantage of this type of protective device is that it is possible to have a short minimum distance and the operator can work more ergonomically.

Hazardous area protection

In hazardous area protection, people are detected if they stay in a defined area.

This type of protective device is suitable for machines, where it is possible to see a hazardous area completely from the reset pushbutton. When the hazardous area is entered, a stop signal is triggered and starting is prevented

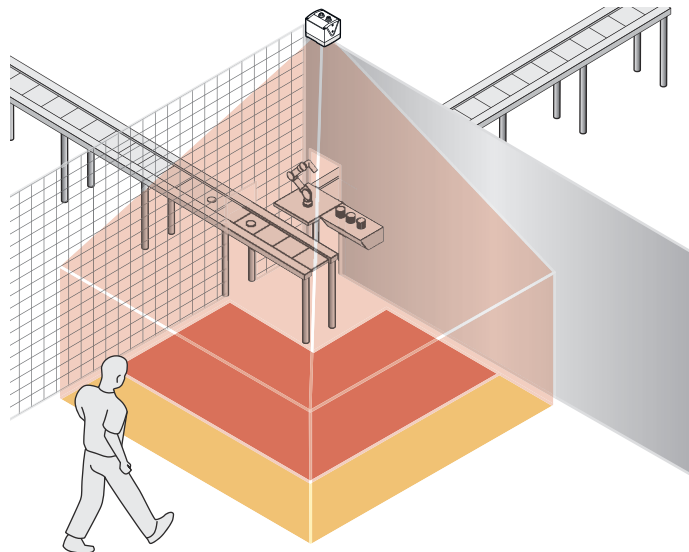

Figure 7: Example of hazardous area protection

Mobile hazardous area protection

Mobile hazardous area protection is suitable for AGVs to protect people when vehicles are moving or docking at a fixed station.

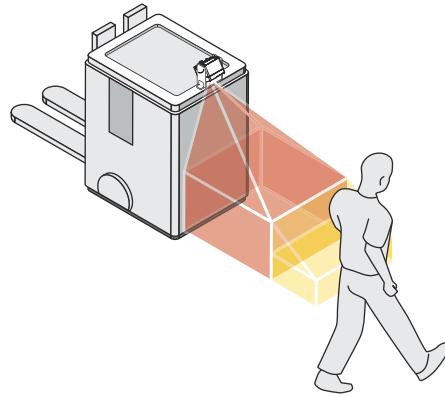

Figure 8: Example of mobile hazardous area protection - personal protection

Collision protection (not safety-related)

The safety camera sensor can detect objects in front of the vehicle and thereby protect the AGV from collisions.

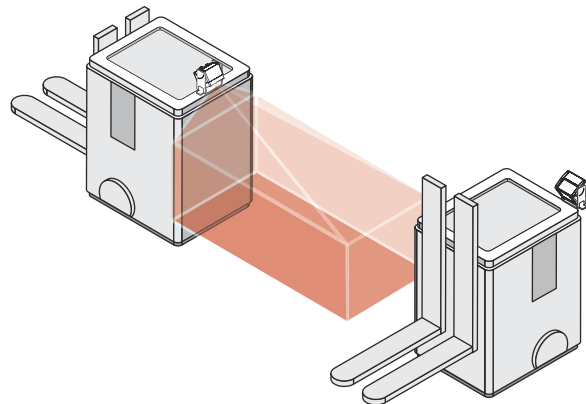

Figure 9: Collision protection example

Access protection

In access protection, people are detected if their whole body passes through the protective field.

This type of protective device is used for the protection of access to hazardous areas. A stop signal is initiated if the hazardous area is entered.

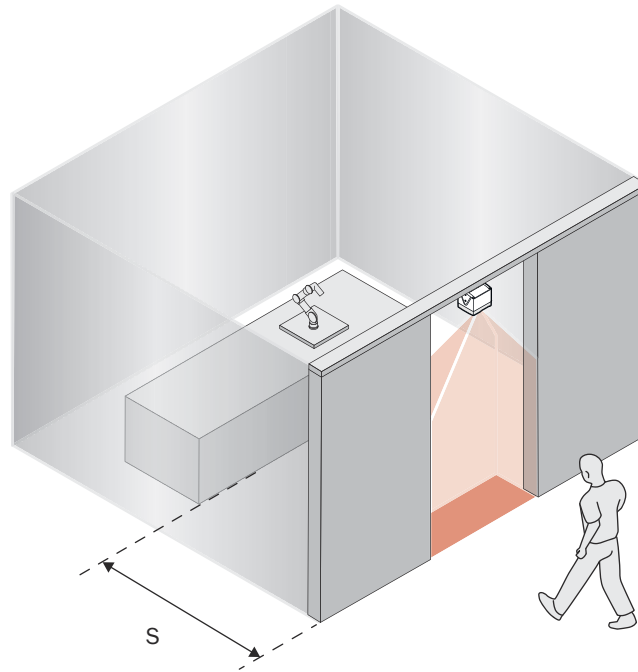

Figure 10: Example of access protection

Fall protection

The fall protection is suitable for AGVs. The ESPE stops the vehicle as soon as the contour in the contour detection field does not correspond to the requirements because, for example, there is an opening in the floor in the direction of travel.

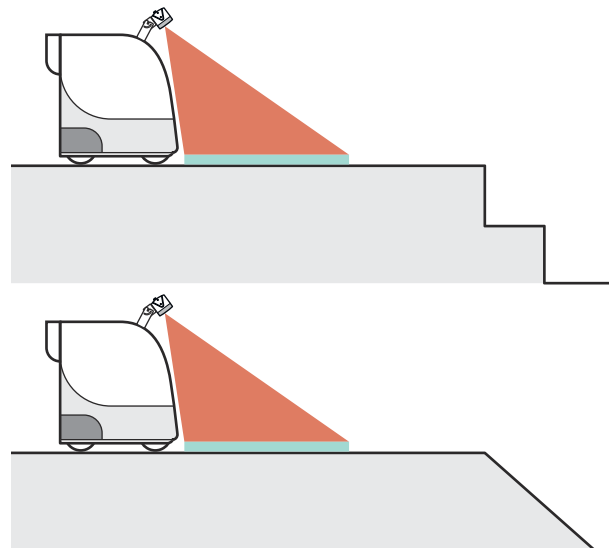

Figure 11: Fall protection example

ROI measurement function

The ROI measurement function provides safe distance measurement values for flexible applications. ROIs (pixel areas) ② are configured in the field of view of the camera system. Within the ROIs, the measuring function calculates safe distance values ①. The safe distance values are compared internally with configured limits (ROI tolerance

band). If values are outside the tolerance band, the camera system switches the associated safety outputs to the OFF state. This function can be used to monitor distance values between AGVs, for example.

Highly reflective surfaces located at a distance < 500 mm from the camera system may cause shutdowns caused by overdrive.

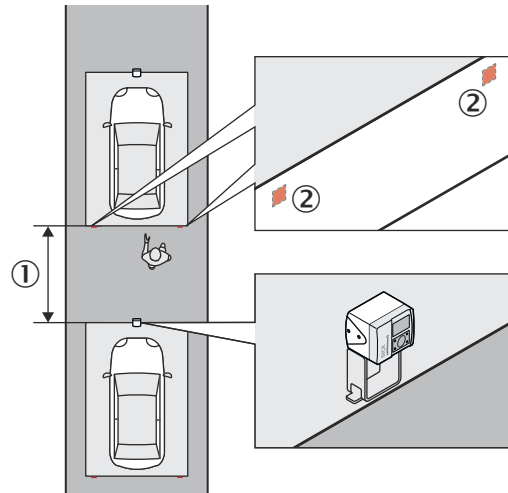

Figure 12: ROI example

- ① Safe distance
- ② ROI

Further topics

- ["ROIs \(region of interest\)", page 69](#)

4 Project planning

4.1 Manufacturer of the machine

The manufacturer of the machinery must carry out a risk assessment and apply appropriate protective measures. Further protective measures may be required in addition to the product.

The product must not be tampered with or changed, except for the procedures described in this document.

The product must only be repaired by the manufacturer of the product or by someone authorized by the manufacturer. Improper repair can result in the product not providing the expected protection.

4.2 Operating entity of the machine

Changes to the electrical integration of the product in the machine controller and changes to the mechanical mounting of the product necessitate a new risk assessment. The results of this risk assessment may require the entity operating the machine to meet the obligations of a manufacturer.

After each change to the configuration, it is necessary to check whether the protective measure provides the necessary protection. The person making the change is responsible for ensuring that the protection measure provides the necessary protection.

The product must not be tampered with or changed, except for the procedures described in this document.

The product must only be repaired by the manufacturer of the product or by someone authorized by the manufacturer. Improper repair can result in the product not providing the expected protection.

4.3 Design

4.3.1 Planning for mounting

Overview

This section contains prerequisites that have to be taken into account when planning for mounting, otherwise the device function may be impaired.

Installation site

- Installation location provides protection against moisture, dirt and damage.
- Installation location allows heat dissipation and convection around the housing of the camera system.
- Status indicators are easily visible after mounting.
- Field of view is not obscured when the device is mounted in an additional housing.
- The field of view area is recessed when mounting the device in an additional housing. Do not use an additional front screen.

Heat regulation

- The device is mounted on a heat-conductive metal surface, e.g., steel or aluminum frame.
- In case of possible overheating or operation above 40 °C ambient temperature, heat sinks are installed or comparable measures are taken.
- When the device is integrated into the contour of a vehicle, convection around the unit is not restricted.

Heat sinks are available at www.sick.com. Enter the product part number in the search field (part number: see the type label entry in the “P/N” field). All suitable accessories are listed on the Accessories tab of the product page.

Strong light sources, lasers and retro-reflectors

- Avoid direct sunlight, infrared light sources and halogen spotlights in the detection zone.
- Laser scanners and other laser sources are not aligned directly with the illumination unit of the camera system.
- The camera system and laser scanner are mounted in such a way that the scan plane of the laser scanner is at least 10 cm away from the camera system.
- The the camera system and other laser source are mounted 10 cm apart, at a slight angle, or tilted.
- Multiple sampling is set to the highest value permitted in the application, taking the minimum distances into account.
- For mobile applications, avoid using retro-reflectors in the driving area and in the area adjacent to the vehicle path.

Smoke, fumes and dust

- If possible, the device is installed in an elevated location and pointed towards the floor.
- Avoid air convection and dust movement directly in front of the front screens, e.g., by setting the device back.
- Front screens are regularly checked for contamination and cleaned.

Objects at close range

Close range is the range from the front screens of the device to 50 mm in front of them.

- The illuminated area is free of free of objects, cables, cladding, etc. in the immediate vicinity of the device.
- No bright or retro-reflective objects are placed at close range.
- The mounting surface does not protrude into the field of view of the camera system.

Undetected areas

The device has a field of view of up to $68^\circ \times 58^\circ$ (horizontal \times vertical), depending on the function. Outside this field of view and depending on the alignment of the camera sensor, there will be areas that are not covered by the device.

- Deflector plates are installed to protect the undetected areas.
- The device is aligned so that people cannot enter unsecured areas.
- AGV: An audible or visual warning signal is used to warn that the vehicle is setting off.
- AGV: Maximum permissible speed for approach is 0.3 m/s.

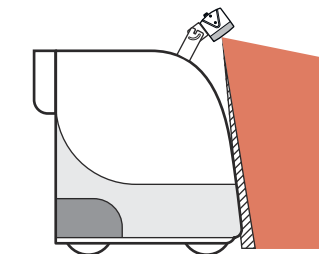

Figure 13: Example of a non-detected area between the vehicle and protective field

Complementary information

Other prerequisites have to be fulfilled depending on the application.

Further topics

- ["Mounting", page 50](#)
- ["Fault indicators", page 85](#)
- ["Planning of the protective field", page 24](#)
- ["Field of view", page 12](#)

4.3.2 Planning of the protective field

Important information



WARNING

Ineffectiveness of the protective device

Strong retro-reflectors or spotlights in the detection zone can interfere with the device and thereby impair detection.

- From a distance of the configured protective fields of 1.5 m in the Z direction and the occurrence of strong spotlights or retro-reflectors in the detection zone, the vertical extension of the configured protective fields must be at least 70 cm.

Protective field

- No obstacles interfere with the view in the protective field of the device. Where there are unavoidable obstacles, additional protective measures are applied.
- If people can be present between the protective device and the hazardous point without being detected, additional protective measures (e.g., restart interlock) are used.
- Reaching under, over and around, crawling beneath and stepping over the device, as well as moving it, are prevented.

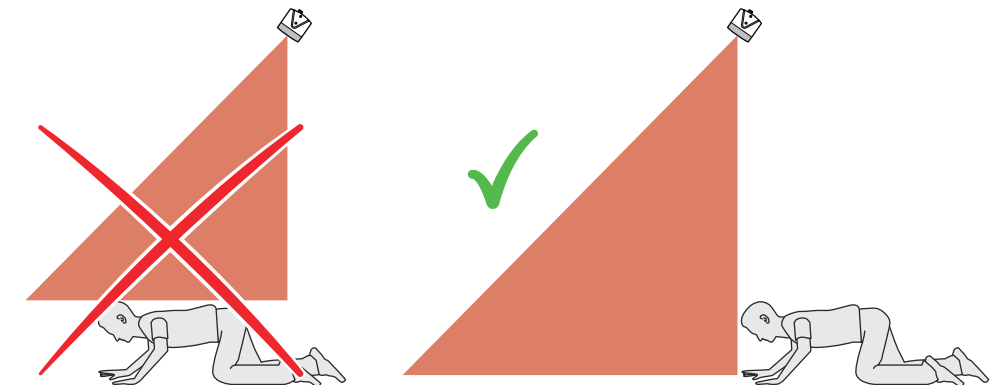

Figure 14: Prevent crawling beneath

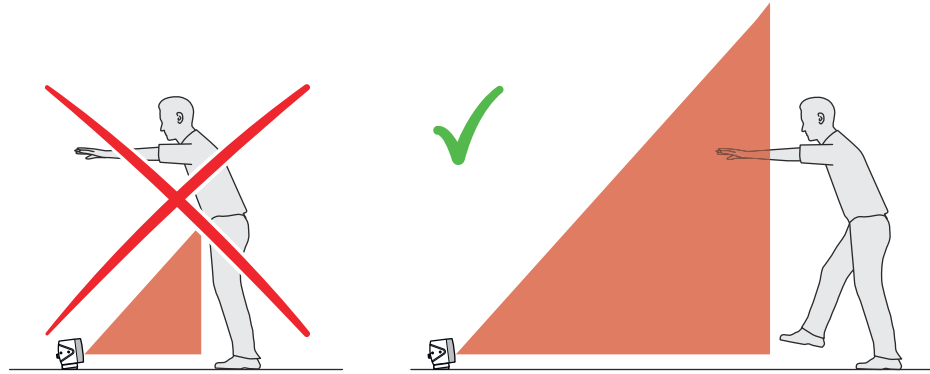

Figure 15: Prevent reaching over

Distance to the floor

To ensure that people lying down are recognized and detected by the protective field, the distance between the bottom of the protective field and the floor should be ≤ 200 mm.

In many cases it is useful to set a distance of 100 mm between the underside of the protective field and the floor. You can set the floor clearance using the 3D view in the Safety Designer. The protection zone on the machine or vehicle must then be verified using a test object.

Distance from walls

The availability may be impaired if the protective field stretches as far as a wall or a different object. A distance of 65 mm is therefore recommended as a tolerance.

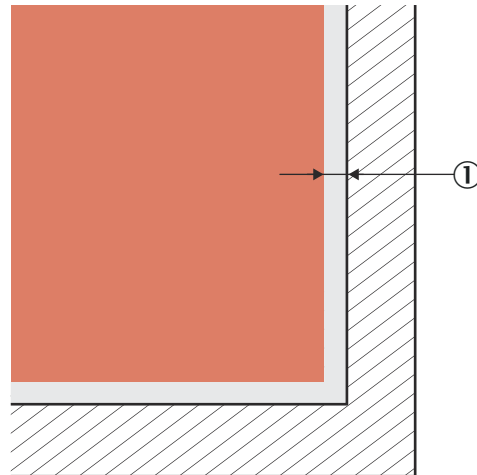

Figure 16: Distance of the protective field from the wall

① Recommended distance of the protective field from the wall: 65 mm

If the distance between the protective field and the wall is so large that a person can stand between them and the protective field is not high enough to recognize the upper body of the person, this person might not be detected. In this case, appropriate measures are required to prevent this occurring, e.g., deflector plates or a fence.

Complementary information

Other prerequisites have to be fulfilled depending on the application.

4.3.3 Timing for monitoring case switching

Overview

If you switch between monitoring cases, you must specify the time at which the switch-over takes place.

When determining the time, you must consider the following points, among others:

- At the time of switchover, one person can already be in the newly activated protective field. The new protective field must therefore be active in good time so that the device detects a person in the newly activated protective field before a hazard arises there.
- In some cases, the process of switching between monitoring cases takes so long that the new monitoring case is not available inside the response time provided. This means that it may not be possible to detect a person in the protective field in time. In cases like this, you must start switching between monitoring cases earlier. The following parameters influence the duration of the process:
 - Set input delay
 - Processing time for the chosen input
- In addition to the parameters considered below, the switching signal's propagation delay time up to the device must also be taken into account. Depending on the communication protocol, these include the network cycle time and the processing time of a controller, for example.

Approach

1. Calculate how long it takes to switch between monitoring cases:

$$t_{CSR} = t_{ID} + t_i$$
 - t_{CSR} = time required for switching between monitoring cases in milliseconds (ms)
 - t_{ID} = input delay for the control inputs, in milliseconds (ms)
 - t_i = processing time for the selected switching type in milliseconds (ms)
 - Local static control input: $t_i = 12$ ms
2. Calculate how much time is available in the response time for switching between monitoring cases:

$$t_{CSA} = (n - n_{CS}) \times t_S$$
 - t_{CSA} = time available for switching between monitoring cases in milliseconds (ms)
 - n = Multiple sampling setting (default: $n = 2$)
 - n_{CS} = Multiple sampling after monitoring case switching for the setting **Fast** (default): $n_{CS} = 1$, for the setting **Robust**: $n_{CS} = n - 1$ (for $n = 1$, $n_{CS} = 1$), for the setting **User defined**: $n_{CS} \leq n - 1$ (for $n = 1$, $n_{CS} = 1$)
 - t_S = Duration of an image acquisition cycle in milliseconds (ms)
3. Compare whether there is enough time available for switching between monitoring cases:
 - If $t_{CSA} \geq t_{CSR}$: No earlier start of the switching process necessary.
 - If $t_{CSA} < t_{CSR}$: switching between monitoring cases must start earlier. Required time advance t_{CSP} : $t_{CSP} = t_{CSR} - t_{CSA}$

Complementary information

In some cases, it is not possible to define when to switch (for example because processing times of the machine vary) or the time advance means that the monitoring of an area finishes too early.

Remedial measures:

- Allow both protective fields to partially overlap.
- Temporarily monitor both hazardous areas simultaneously.

Further topics

- "Input delay", page 74
- "Control inputs", page 40

4.3.4 Approach direction**Overview**

A person can approach the protective field orthogonally or parallel to the optical axis. The calculation of the minimum distances differs depending on the approach direction.

Orthogonal approach to the optical axis

When approaching orthogonally to the optical axis, a person approaches the protective field from the side.

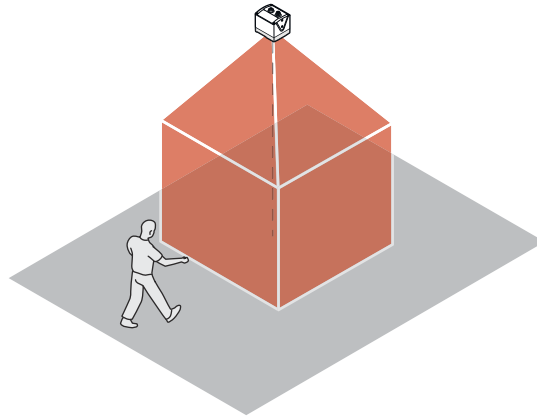

Figure 17: Orthogonal approach to the optical axis, example 1

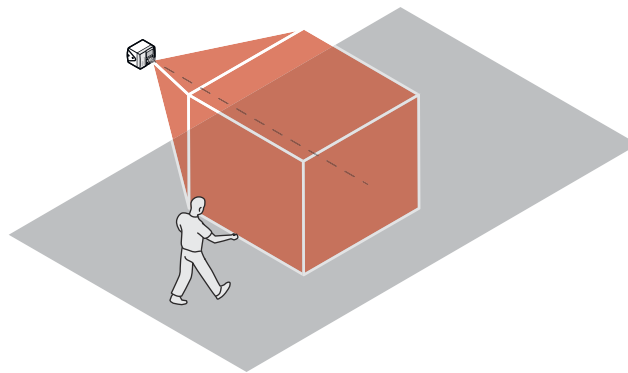

Figure 18: Orthogonal approach to the optical axis, example 2

Parallel approach to the optical axis

When approaching parallel to the optical axis, a person enters the protective field at the further end. The person walks towards the camera system.

Depending on the application and the selected object resolution, larger allowances are required for an approach direction parallel to the optical axis. For example, if a person enters the protective field with an outstretched arm, the camera system sees the entire length of the arm when approaching orthogonally. When approaching parallel to the optical axis, the camera system sees only the fingertips or the arm diameter. A larger allowance is therefore necessary when calculating the minimum distance.

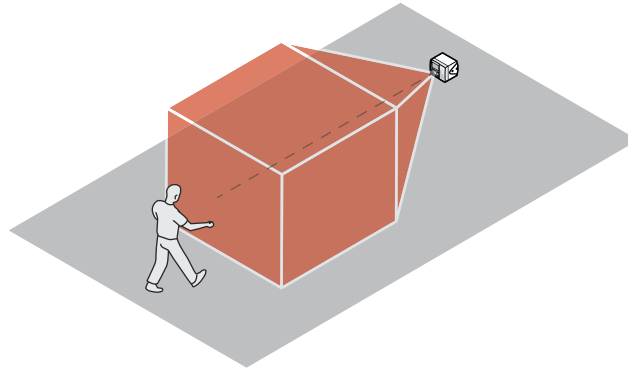

Figure 19: Parallel approach to the optical axis

4.3.5 Minimum distance for stationary applications

Overview

The protective field must be designed to recognize a person at the latest when he or she reaches the minimum distance from the hazardous point. The minimum distance means that the dangerous state can be ended in good time before the person reaches the hazardous point.

Minimum distance for stationary applications

The calculation of the minimum distance is based on international or national standards and statutory requirements applicable at the place of installation of the machine.

If the minimum distance is calculated according to ISO 13855, then it depends on the following points:

- Machine stopping time (time interval between triggering the sensor function and the end of the machine's dangerous state, if necessary including signal propagation times in the network and processing time in the controller)
- Response time of the protective device
- Reach or approach speed of the person
- Resolution (detection capability)
- Type of approach
- Switching time between monitoring cases
- Parameters specified based on the application
- Supplements for general and, possibly, reflection-based measurement errors (only for hazardous area protection)
- Supplement for protection against reaching over (only for hazardous area protection)
- Supplement to prevent reaching through (only for access protection)

Complementary information

More information is available in the ISO 13855 standard and in the Guide for Safe Machinery from SICK.

SICK offers a stopping/run-down time measurement service in many countries.

4.3.6 Hazardous area protection

Hazardous area protection

The safety camera sensor is mounted in a stationary application, for example on a machine where the hazardous area is not completely surrounded by a physical guard.

When used for hazardous area protection, the camera sensor detects the person. The camera sensor is mounted in such a way that the protective field scans the immediate hazardous area around a machine and detects an approaching movement. The camera sensor can be arranged horizontally or vertically for this purpose.

To monitor the largest possible area, vertical arrangement of the camera sensor and use of the **Increased scanning range** mode are suitable.

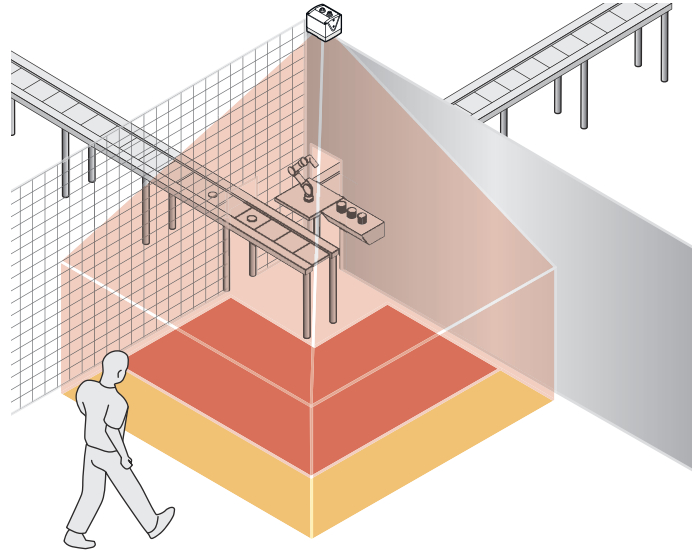

Figure 20: Hazardous area protection

Complementary information

Marking the course of the protective field boundaries on the floor is recommended. By doing this, you allow operating personnel to see the protective field boundaries and make it easier to test at a later date.

4.3.6.1 Protective field

For hazardous area protection, the minimum distance typically determines the geometry and location of the protective field.

If you define a number of monitoring cases with different protective fields, you must calculate the protective field size separately for each protective field used.

For hazardous area protection, an object resolution of **Body** is suitable in most cases.

4.3.6.2 Calculation example for the minimum distance

Overview

The following examples show the calculation of the minimum distance S for an approach orthogonal or parallel to the optical axis (Z-axis) of the camera sensor. The calculation is performed in accordance with ISO 13855 and the specific specifications of the camera sensor. A different calculation may be required depending on the application and the ambient conditions, for example when approaching the optical axis of the camera sensor at any angle.

Minimum distance S with orthogonal approach to the optical axis

$$S = 1,600 \text{ mm/s} \times T + C$$

Where:

- S = minimum distance, in millimeters (mm)
- T = stopping/run-down time for the entire system, in seconds (s)
(Response time of the device + machine's stopping/run-down time, including response time of the machine's control system and signal propagation time)
- C = supplement in millimeters (mm)

The reach/approach speed is already included in the formula.

Table 8: Supplement C with orthogonal approach to the optical axis, hazardous area protection

Object resolution Hand	Object resolution Arm	Object resolution Leg	Object resolution Body
160 mm	300 mm	350 mm	550 mm 850 mm when using Increased scanning range mode

Minimum distance S with parallel approach to the optical axis

$$S = 1,600 \text{ mm/s} \times T + T_z + C$$

Where:

- S = minimum distance, in millimeters (mm)
- T = stopping/run-down time for the entire system, in seconds (s)
(Response time of the device + machine's stopping/run-down time, including response time of the machine's control system and signal propagation time)
- TZ = tolerance zone of the device
- C = supplement in millimeters (mm)

The reach/approach speed is already included in the formula.

Table 9: Supplement C with parallel approach to the optical axis, hazardous area protection

Object resolution Hand	Object resolution Arm	Object resolution Leg	Object resolution Body
160 mm	850 mm	850 mm	850 mm

Further topics

- Tolerance zone of the device (TZ) [see table 45, page 92](#)
- ["Approach direction", page 27](#)

4.3.7 Hazardous point protection

Hazardous point protection

The safety camera sensor is mounted in a stationary application, for example on a machine where the operating personnel must stay close to the hazardous point. A fixed barrier with a height of at least 1,200 mm is located in front of the hazardous point. The operating personnel can reach over the barrier and through the detection zone into the hazardous point. But the operating personnel cannot climb over the barrier. If there is no such barrier available, access protection may be required.

When used for hazardous point protection, the safety camera sensor detects the hand or arm of a person. The camera sensor is typically aligned vertically.

4.3.7.1 Protective field

Protective field

In hazardous point protection, the minimum distance typically determines the position at which the device is mounted. Access to the hazardous point shall only be possible through the protective field.

For hazardous point protection, a resolution of **Hand** or **Arm** is suitable in most cases. Due to this resolution, the camera sensor is not suitable for finger detection.

Complementary information

The required minimum distance depends, among other things, on the resolution set on the device.

Notes on selecting the resolution:

- If you choose a fine resolution, the protective field range is smaller and the protective field is only suitable for smaller hazardous points. The required minimum distance is smaller, however, so you can mount the device closer to the hazardous point.
- If you choose a coarser resolution, the protective field range is larger and the protective field is also suitable for larger hazardous points. The required minimum distance is larger, however, so you need to mount the device further away from the hazardous point.

4.3.7.2 Calculation example for the minimum distance

Overview

The following examples show the calculation of the minimum distance S for an approach orthogonal or parallel to the optical axis (Z-axis) of the camera sensor. The calculation is performed in accordance with ISO 13855 and the specific specifications of the camera sensor. A different calculation may be required depending on the application and the ambient conditions, for example when approaching the optical axis of the camera sensor at any angle.

Minimum distance S with orthogonal approach to the optical axis

$$S = 2,000 \text{ mm/s} \times T + C$$

Where:

- S = minimum distance, in millimeters (mm)
- T = stopping/run-down time for the entire system, in seconds (s)
(Response time of the device + machine's stopping/run-down time, including response time of the machine's control system and signal propagation time)
- C = supplement in millimeters (mm)

The reach/approach speed is already included in the formula.

Table 10: Supplement C for approach orthogonal to the optical axis, hazardous point protection

Object resolution Hand	Object resolution Arm	Object resolution Leg	Object resolution Body
160 mm	300 mm	Object resolution is not applicable to this application.	Object resolution is not applicable to this application.

Minimum distance S with parallel approach to the optical axis

$$S = 2,000 \text{ mm/s} \times T + T_z + C$$

Where:

- S = minimum distance, in millimeters (mm)
- T = stopping/run-down time for the entire system, in seconds (s)
(Response time of the device + machine's stopping/run-down time, including response time of the machine's control system and signal propagation time)
- T_z = tolerance zone of the device
- C = supplement in millimeters (mm)

The reach/approach speed is already included in the formula.

Table 11: Safety supplement C with parallel approach to the optical axis, hazardous point protection

Object resolution Hand	Object resolution Arm	Object resolution Leg	Object resolution Body
160 mm	850 mm	Object resolution is not applicable to this application.	Object resolution is not applicable to this application.

Further topics

- Tolerance zone of the device (TZ) [see table 45, page 92](#)
- ["Approach direction", page 27](#)

4.3.8 Access protection

Access protection

The camera system is mounted on the passageway. In access protection applications, the camera sensor detects the entry of an entire body.

The following fields are suitable for access protection:

- Protective field
- Contour detection field

The contour detection field also avoids detection gaps due to inadvertent maladjustment of the camera or due to manipulation.

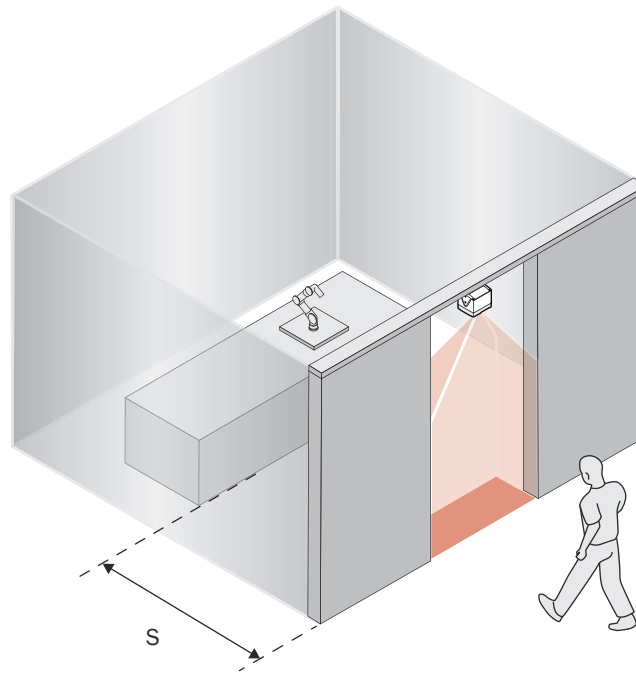

Figure 21: Access protection

4.3.8.1 Protective field

In access protection, the minimum distance typically defines the position at which the device is mounted.

The protective field must be dimensioned so that a person cannot step over the protective field. The protective field must either be 900 mm high or extend at least 500 mm in the direction of movement.

For protective fields extending > 100 cm, any multiple sampling setting can be selected. For protective fields extending < 100 cm, the multiple sampling setting must be no greater than 3. Otherwise a person could walk undetected through the protective field.

4.3.8.2 Calculation example for the minimum distance

Overview

The following examples show the calculation of the minimum distance S for an approach orthogonal or parallel to the optical axis (Z-axis) of the camera sensor. The calculation is performed in accordance with ISO 13855 and the specific specifications of the camera sensor. A different calculation may be required depending on the application and the ambient conditions, for example when approaching the optical axis of the camera sensor at any angle.

Minimum distance S with orthogonal approach to the optical axis

$$S = 1,600 \text{ mm/s} \times T + C$$

Where:

- S = minimum distance, in millimeters (mm)
- T = stopping/run-down time for the entire system, in seconds (s)
(Response time of the device + machine's stopping/run-down time, including response time of the machine's control system and signal propagation time)
- C = supplement in millimeters (mm)

The reach/approach speed is already included in the formula.

Table 12: Supplement C with orthogonal approach to the optical axis, access protection

Object resolution Hand	Object resolution Arm	Object resolution Leg	Object resolution Body
Object resolution is not applicable to this application.	Object resolution is not applicable to this application.	70 mm	170 mm

Minimum distance S with parallel approach to the optical axis

$$S = 1,600 \text{ mm/s} \times T + T_z + C$$

Where:

- S = minimum distance, in millimeters (mm)
- T = stopping/run-down time for the entire system, in seconds (s)
(Response time of the device + machine's stopping/run-down time, including response time of the machine's control system and signal propagation time)
- TZ = tolerance zone of the device
- C = supplement in millimeters (mm)

The reach/approach speed is already included in the formula.

Table 13: Supplement C with parallel approach to the optical axis, access protection

Object resolution Hand	Object resolution Arm	Object resolution Leg	Object resolution Body
Object resolution is not applicable to this application.	Object resolution is not applicable to this application.	70 mm	170 mm

Further topics

- Tolerance zone of the device (TZ) [see table 45, page 92](#)
- ["Approach direction", page 27](#)

4.3.9 Mobile hazardous area protection

Overview

The camera sensor is mounted in a mobile application, for example on an automatic guided vehicle. In mobile hazardous area protection, the camera sensor protects the hazardous area created by the vehicle's movement.

The camera sensor detects the legs or body of a person depending on the object resolution. The protective fields must cover all hazardous areas around the vehicle, the general driving area directly in front of the vehicle and, if applicable, additional hazardous areas along the lateral contour of the vehicle. The extent of the protective fields must be selected so that the required minimum distances, tolerance zones, and stopping distances are contained within them.

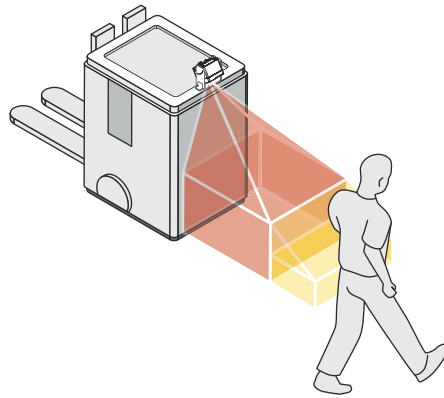

Figure 22: Mobile hazardous area protection

Important information



NOTE

In the following calculation examples, only the vehicle speed is taken into account, not the speed of a walking person. This is based on the assumption that the person recognizes the danger and stands still.

4.3.9.1 Protective field

In mobile hazardous area protection, the minimum distance typically determines the protective field size required. The minimum distance allows the vehicle to stop in time before it reaches a person or an object. When calculating the protective field length, the impact of turning must be considered separately.

The protective field must be wide enough to cover the width of the loaded vehicle plus supplements for measurement error and the clearance from the floor.

If you define a number of monitoring cases with different protective fields, you must calculate the protective field size separately for each protective field used.

4.3.9.2 Calculation example for the protective field length

Overview

Parallel approach to the optical axis is assumed for mobile hazardous area protection.

Calculation example for the protective field length S_L

$$S_L = S_A + TZ + Z_F + Z_B + C$$

Where:

- S_L = protective field length, in millimeters (mm)
- S_A = stopping distance, in millimeters (mm)
- TZ = tolerance zone of the device
- Z_F = supplement for lack of floor clearance of the vehicle, in millimeters (mm)
- Z_B = supplement for the decreasing braking force of the vehicle, from the vehicle documentation, in millimeters (mm)
- C = supplement in millimeters (mm)

Table 14: Supplement C, mobile hazardous area protection

Object resolution Hand	Object resolution Arm	Object resolution Leg	Object resolution Body
Object resolution is not applicable to this application.	Object resolution is not applicable to this application.	70 mm	170 mm

The information in the table assumes that the collision hazard is between the vehicle and the legs or body of a person.

Further topics

- ["Stopping distance \$S_A\$ ", page 35](#)
- ["Approach direction", page 27](#)

4.3.9.3 Calculation example for the protective field width

Prerequisites

- The protective field in front of the vehicle is symmetrical in shape.

Calculation example for the protective field width S_B

$$S_B = F_B + 2 \times (TZ + Z_F)$$

Where:

- S_B = protective field width, in millimeters (mm)
- F_B = vehicle width, in millimeters (mm)
- TZ = tolerance zone of the device
- Z_F = supplement for lack of floor clearance of the vehicle, in millimeters (mm)

4.3.9.4 Stopping distance S_A

The stopping distance is the sum of the following distances:

- Braking distance of the vehicle
- Distance traveled during the response time of the safety camera sensor
- Distance covered during the response time of the vehicle control (incl. signal propagation time)

A vehicle's braking distance does not increase linearly with increasing speed, but rather in a squared relationship.

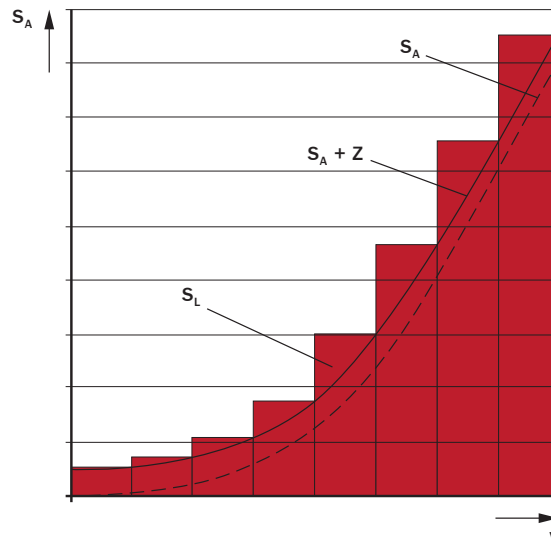

Figure 23: Stopping distance as a function of the vehicle's speed

- v Speed
- S_A Stopping distance
- Z Supplements
- S_L Protective field length for the relevant range of speeds

$$S_A = S_{Br} + S_{AnF} + S_{AnS}$$

Where:

- S_A = stopping distance, in millimeters (mm)
- S_{Br} = braking distance, from the vehicle documentation, in millimeters (mm)
- S_{AnF} = distance covered during the vehicle control's response time (including signal propagation time), from the vehicle documentation, in millimeters (mm)
- S_{AnS} = distance traveled during the response time of the safety camera sensor, in millimeters (mm)

The distance S_{AnS} depends on the response time of the safety camera sensor and the speed of the vehicle. The distance S_{AnS} is calculated using the following formula:

$$S_{AnS} = t_R \times V_{max}$$

Where:

- t_R = response time of the safety camera sensor, in seconds (s)
- V_{max} = maximum speed of the vehicle, from the vehicle documentation, in millimeters per second (mm/s) (If you define a number of monitoring cases with different protective fields: V_{max} = maximum speed of the vehicle in the current monitoring case)

4.3.10 Fall protection

The safety camera sensor is mounted in a mobile application, e.g., on an AGV. When used for fall protection, the safety camera sensor detects openings in the floor and protects the vehicle against falling.

The camera system is mounted at a minimum height of 50 cm.

The contour detection field is configured via a teach-in process and corresponds to the floor level in front of the vehicle.

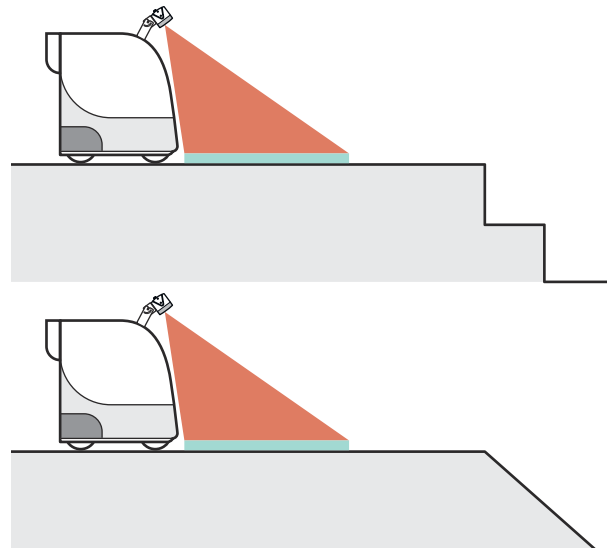

Figure 24: Fall protection

4.3.10.1 Contour detection field

Contour detection field

The contour detection field must be designed in such a way that it recognizes an opening in the floor at the latest when the vehicle is at the minimum distance to the opening. The minimum distance allows the vehicle to stop in time before it reaches the opening.

With fall protection, the minimum distance determines the required length of the contour detection field.

The contour detection field must be wide enough to cover the width of the vehicle.

The size of the relevant opening can be selected in the Safety Designer via the **Object resolution** setting. Openings of at least the selected size are detected and cause the vehicle to stop.

When calculating the contour detection field, the impact of turning must be considered separately.

If you define a several monitoring cases with different protective fields, you must calculate the contour detection field size separately for each contour detection field used.

Influence of dark, shiny or reflective floor coverings

Very dark, shiny or reflective floor coverings can in some cases cause the camera sensor to incorrectly detect an opening and stop the vehicle.

Measures to increase availability:

- ▶ If possible, select a large object resolution (100x100 cm).
- ▶ Install the camera sensor higher and adjust the viewing direction to the ground at a steeper angle. Alternatively, you can reduce the scanning range of the contour detection field if possible.

4.3.10.2 Calculation example for the length of the contour detection field

Calculation example for the length of contour detection field K_L

$$K_L = S_A + Z_B + Z_O$$

Where:

- K_L = extent of the contour detection field along the floor in millimeters (mm)
- S_A = stopping distance, in millimeters (mm)
- Z_B = supplement for the decreasing braking force of the vehicle, from the vehicle documentation, in millimeters (mm)
- Z_O = size of the selected object resolution in Safety Designer in millimeters (mm): 400 mm for a small opening or 1,000 mm for a large opening

Further topics

- ["Stopping distance \$S_A\$ ", page 35](#)

4.3.10.3 Calculation example for the width of the contour detection field

Calculation example for the width of contour detection field K_B

$$K_B = F_B + 2 \times TZ$$

Where:

- K_B = width of the contour detection field in millimeters (mm)
- F_B = vehicle width, in millimeters (mm)
- TZ = tolerance zone of the device

Complementary information

If only part of the opening protrudes into the vehicle travel path from the side, this design of the width may result in the opening not being detected. The vehicle could drive into the opening and crash to the side. To prevent this, a lateral supplement corresponding to the configured object resolution (gap size) may need to be added to the contour detection field.

4.4 Integration in the electrical control system

Requirements for use

- The control of the machine can be electrically influenced.
- The connected controller and all devices responsible for safety comply with the required performance level and the required category (for example according to ISO 13849-1).
- Power is supplied to all electrically connected devices in accordance with SELV/PELV (IEC 60204-1).
- All devices connected to a local input or output are in the same SELV/PELV circuit as the product.
- All electrically connected devices use the same earthing method.
- All earthing points are connected with the same ground potential.

Further topics

- ["Electrical installation", page 52](#)

4.4.1 Electromagnetic compatibility

Overview

Safety components switch all safety outputs to the OFF state in the event of errors in order to rule out potentially dangerous situations. For example, faulty data transmission must lead to a shutdown for safety-related devices, even if it can be tolerated for non-safety-related devices.

To avoid electromagnetic interference as much as possible, a consistent earthing method is required for the entire system. In particular, the functional earth must be connected using suitable conductors. Cables susceptible to interference and sources of interference should be routed separately.

Electromagnetic interference depends on the environment in which the product is used. The product is tested and certified according to common standards. It is therefore reliable when used in industrial environments.

Shielded cables

For shielded cables, the shielding should be applied on both sides and over a large area. Deviations are only permitted in exceptional and justified cases. Especially when using motors or other inductive consumers, one-sided support of the shielding is not sufficient because it does not act against inductive interferers.

Functional earth

The functional earth must be connected. The connection must be made in accordance with the earthing method of the system.

Options for connecting the functional earth:

- Thread on the M12 plug connector
- Additionally via M5 threaded holes on the side and bottom of the housing

The functional earth must be connected with low inductance, i.e. with a sufficient wire cross-section and the shortest possible length of cable.

Complementary information

Additional information on electromagnetic compatibility can be found in the technical information EMC background information, part no. 8027030.

4.4.2 Voltage supply

Prerequisites

- The power supply unit is able to jumper a brief power failure of 20 ms as specified in IEC 60204-1.
- The power supply unit provides safe isolation according to IEC 61140 (SELV/PELV as per IEC 60204-1).
- The electrical voltage supply has a suitable electrical fuse.

Further topics

- ["Data sheet", page 92](#)

4.4.3 OSSDs

Overview

When the protective field is clear, the OSSDs signal the ON state and the signal level is HIGH (non-isolated). If there are objects in the protective field or there is a device fault, the OSSDs signal the OFF state with the LOW signal level.

Downstream control elements must evaluate the output signals of the protective device in such a way that the dangerous state of the machine is safely ended. Depending on the safety concept, the signal is analyzed by safety relays or a safety controller, for example.

The OSSDs are short-circuit proof against 24 VDC and 0 V.

Prerequisites

- The machine switches to the safe state if, at any time, at least one OSSD in an OSSD pair switches to the OFF state.
- When using a safety controller: The safety controller detects different signal levels of the two OSSDs of an OSSD pair (depending on national regulations or required reliability of the safety function). The maximum discrepancy time tolerated by the control is selected according to the application.
- The output signals from an OSSD pair are not connected to each other.
- The machine controller processes both signals of an OSSD pair separately.

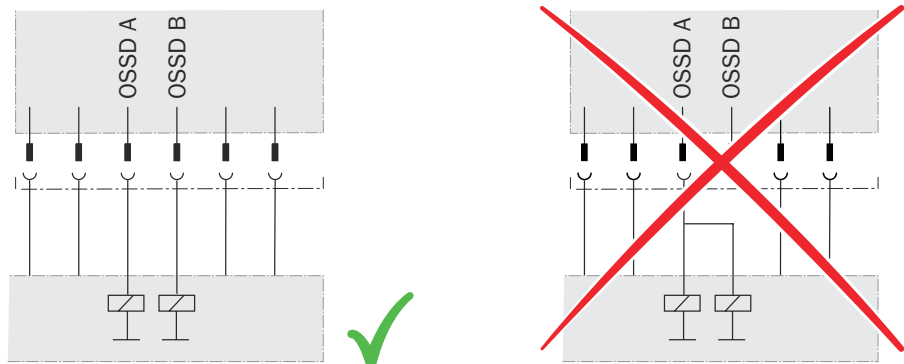

Figure 25: Dual-channel and isolated connection of an OSSD pair

- No potential difference can occur between the load and the protective device. The 0 V connections of the load and those of the associated protective device are connected individually and directly to the same 0 V terminal strip. In the event of a fault, this is the only way to ensure that there can be no potential difference between the 0 V connections of the loads and those of the corresponding protective device. This is particularly important for loads that switch even if they are activated with negative voltage (e.g. electromechanical contactor without reverse polarity protection diode).

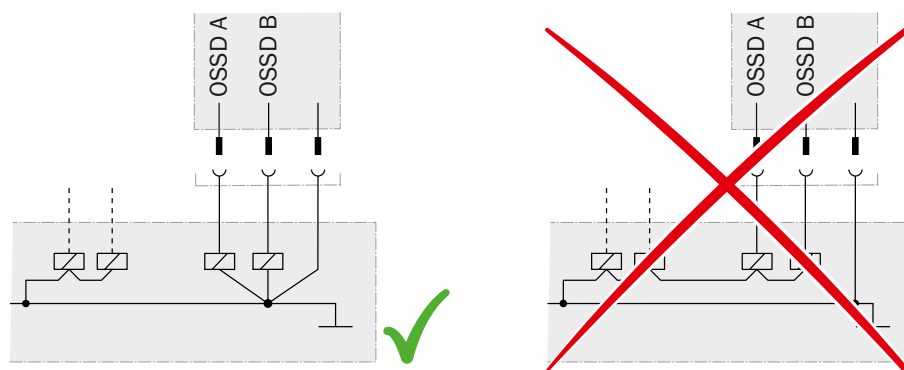

Figure 26: No potential difference between load and protective device

Further topics

- ["Course of the OSSD test over time", page 96](#)

4.4.4 Control inputs

Overview

The control inputs accept signals for switching between different monitoring cases.

Static control inputs are used for information about machine status.

Prerequisites

- The safety-related parts of the controller that switch the active protective field provide the same safety level as the safety function.
- Manual switching that depends on the operating mode is carried out using a suitable manual control switch.

Further topics

- ["Data sheet", page 92](#)
- ["Electrical installation", page 52](#)
- ["Inputs and outputs, local", page 69](#)

4.4.4.1 Static control inputs, Parity inputs**Overview**

The static control inputs support the following evaluation methods:

- Complementary evaluation
- 1-of-n evaluation

The parity inputs support the following evaluation methods:

- Parity check

Complementary evaluation

A static control input consists of 2 channels in the case of complementary sampling. The channels of a static control input are switched inversely. The following table shows which status the static control input's channels must have to define logical input condition 1 and 0 at the relevant control input.

Table 15: Status of the channels of the control inputs with complementary evaluation

A1	A2	Logical input status (input A)
1	0	0
0	1	1
1	1	Error
0	0	Error

1-of-n evaluation

With the 1-out-of-n evaluation, each channel of a control input is considered individually. At any time, exactly one channel must have logic value 1.

Table 16: True vales with 1-off-n-evaluation with 2 input pairs (example)

A1	A2	B1	B2	Result (e.g. monitoring case no.)
1	0	0	0	1
0	1	0	0	2
0	0	1	0	3
0	0	0	1	4
Other input conditions				Error

Parity check

You can use 3 channels or 4 channels for the parity check. This gives 4 or 8 monitoring cases, respectively. The following tables show what state the channels of the static control input must have in order to obtain a valid input combination.

Table 17: State of the channels of the control inputs for a parity check using 3 channels

P3.1	P3.2	P3.P	Result (e.g., monitoring case no.)
0	0	1	0
0	1	0	1
1	0	0	2
1	1	1	3
Other input conditions			Error

Table 18: State of the channels of the control inputs for a parity check using 4 channels

P4.1	P4.2	P4.3	P4.P	Result (e.g., monitoring case no.)
0	0	0	1	0
0	0	1	0	1
0	1	0	0	2
0	1	1	1	3
1	0	0	0	4
1	0	1	1	5
1	1	0	1	6
1	1	1	0	7
Other input conditions				Error

Complementary information

- When the input signal is changed, the previous monitoring case remains active for the duration of the set switch-on delay. If no valid input signal is present after the switch-on delay has elapsed, the behavior depends on the sequence monitoring:
 - If monitoring of the switching sequence (sequence monitoring) is not activated, the OSSDs switch to the OFF state after the switch-on delay has elapsed. If a valid input signal is present within another second, the device activates the new monitoring case. If no valid input signal is present within this time, the OSSDs remain in the OFF state and the device displays an error and must be restarted.
 - If monitoring of the switching sequence (sequence monitoring) is activated, the OSSDs switch to the OFF state after the switch-on delay has elapsed and the device displays an error and must be restarted.
- A short-circuit or cross-circuit on one or more channels of the static control inputs can cause the wrong monitoring case to be activated.
 - Some safety controllers detect the short-circuit or cross-circuit and switch off their outputs or some of their outputs.
 - Due to the short-circuit or cross-circuit, one or more input channels of the device can nevertheless deliver the HIGH signal level. This may result in a valid input signal so that a monitoring case is activated.
 - For this reason, laying the cables for the input signals in a protected manner is recommended. Otherwise, setting the switch-on delay to 0 s and activating sequence monitoring is recommended. Carrying out regular thorough checks at short intervals is also recommended.

Further topics

- ["Settings for monitoring case tables", page 73](#)
- ["System connection", page 52](#)

4.4.5 Universal inputs, universal outputs, universal I/Os

Universal I/O can be configured as universal input or as universal output. In addition, certain universal I/Os can be used in pairs as OSSD pairs.

A universal input can be used, for example, for resetting, external device monitoring (EDM), sleep mode, or restarting the protective device. If sleep mode is activated by a universal input, the sleep mode must not be used for safety applications. Certain universal inputs can also be used in pairs as a static control input.

A universal output outputs a specific signal depending on its configuration, e.g., if the reset pushbutton needs to be pushed, or if the front screens are contaminated. A universal output must not be used for safety functions.

A universal I/O that has not been configured behaves like an input (high impedance).

Further topics

- ["Electrical installation", page 52](#)
- ["Technical data", page 92](#)

4.4.6 Restart interlock

Overview

Depending on the regulations which apply at the place of installation, a restart interlock may be required.

The restart interlock prevents the machine from automatically starting up, for example after a protective device has responded while the machine is operating or after changing the machine's operating mode.

First, the operator must press a reset pushbutton to return the protective device to monitoring status. Then, in a second step, the operator can restart the machine.

Prerequisites

- The control switch for resetting the restart interlock (reset pushbutton) is mounted outside the hazardous area.
- Persons within the hazardous area cannot operate the reset pushbutton.
- Any person operating the control switch can view the entire hazardous area.

Internal restart interlock

Each safety output of the device is equipped with a configurable internal restart interlock.

When the internal restart interlock is used, the sequence is as follows:

- 1 A safety output of the device switches to the OFF state if there is an interruption in the protective field.
- 2 The safety output remains in the OFF state when there is no longer an object in the protective field.
- 3 The safety output only switches back to the ON state when the operator presses the reset pushbutton, which is outside the hazardous area. If there is an object in the protective field when the reset pushbutton is pressed, the safety output stays in the OFF state.
- 4 After the reset, the operator can restart the machine in a second step.

4.4.7 External device monitoring (EDM)

Overview

The external switching elements (external device monitoring, EDM) must be inspected in line with the regulations which apply at the place of installation or the required reliability of the safety function.

The external device monitoring (EDM) monitors the status of downstream contactors.

Prerequisites

- Positively guided contactors are used for shutting down the machine. If the auxiliary contacts of the positively guided contactors are connected to the external device monitoring, the external device monitoring checks whether the contactors switch correctly when the OSSDs are switched off.

4.5 Integration into the network

4.5.1 Network topology

The device is suitable for the following network topologies:

- Star

4.5.2 Network services and ports

Table 19: Network services and ports

Use	Protocol	Source	Source port	Target	Destination port
DHCP	UDP	safeVisionary2	68	DHCP server	67
		DHCP server	67	safeVisionary2	68
CoLa2 (protocol from SICK, configuration and diagnosis)	TCP	CoLa2 client, e.g., computer with Safety Designer	Selected by CoLa2 client	safeVisionary2	2122
		safeVisionary2	2122	CoLa2 client, e.g., computer with Safety Designer	Selected by CoLa2 client
CoLa2 (protocol from SICK, device search)	UDP	Computer with Safety Designer	30,718 ... 30,738	safeVisionary2 or Limited Broadcast or Directed Broadcast	30718
		safeVisionary2	30718	Computer with Safety Designer (if in the same subnet) or Broadcast (if in a different subnet)	30,718 ... 30,738
Data output in transmit mode continuous	UDP	safeVisionary2	Randomly selected	Target computer	Configurable

4.6 Testing plan

Testing plan

The manufacturer of the machine and the operating entity must define all required thorough checks. The definition must be based on the application conditions and the risk assessment and must be documented in a traceable manner.

The following tests must be planned:

- A thorough check must be carried out during commissioning and following modifications.
- The regular tests of the device must fulfill certain minimum requirements.

Test object

A test object is required for some thorough checks. The size of the test object must, if possible, correspond to the configured resolution. A suitable test object is an opaque cylinder with a matte black surface.

Table 20: Test object

Object resolution	Test object	
	Diameter	Length
Hand	20 mm	≥ 160 mm
Arm	40 mm	≥ 300 mm
Leg	50 mm	≥ 300 mm
Body	200 mm	≥ 200 mm

4.6.1 Planning the thorough check during commissioning and in certain situations

Overview

Before commissioning the machine and after making changes, you must check whether the safety functions are fulfilling their planned purpose and whether persons are being adequately protected.

Minimum requirements

The protective device and its application must be thoroughly checked in the following situations:

- Before commissioning
- After changes to the configuration or the safety function
- After changes to the mounting, the alignment, or the electrical connection
- After exceptional events, such as after manipulation has been detected, after modification of the machine, or after replacing components

The thorough check ensures the following:

- All relevant regulations are complied with and the protective device is active for all of the machine's operating modes. This includes the following points:
 - compliance with standards
 - correct use of the protective device
 - suitable configuration and safety function
 - correct alignment
- The documentation accurately reflects the state/condition of the machine, including the protective device.
- The verified configuration report matches the desired project planning (see ["Verify configuration", page 77](#)).

The thorough checks must be carried out by qualified safety personnel or specially qualified and authorized personnel, and must be documented in a traceable manner.

Recommended thorough checks

In many cases, it makes sense to carry out the following thorough checks during commissioning and in certain situations:

- Test of the relevant points on the checklist, see ["Checklist for initial commissioning and commissioning", page 108](#)
- ["Visual check of the machine and the protective device", page 48](#)
- ["Thorough check of the principal function of the protective device", page 46](#)
- ["Thorough check of the area to be protected", page 47](#)
- ["Test of the contour detection field", page 48](#)
- Instruction of the operating personnel in the function of the protective device

4.6.2 Planning the regular thorough check

Overview

The purpose of regular tests is to identify any defects due to changes or external influences (e.g. damage or manipulation) and to ensure that the protective measure provides the necessary protection.

Important information



WARNING

Hazard due to lack of effectiveness of the protective device

Persons and parts of the body to be protected may not be recognized in case of non-observance.

- ▶ Carry out tests at least once a year.
 - ▶ Assign qualified safety personnel to carry out the tests or persons specifically authorized for this purpose.
 - ▶ Document tests in a traceable manner.
-

Minimum requirements

The following thorough checks must be carried out at least once a year:

- ["Thorough check of the principal function of the protective device"](#), page 46
- Test of the detection capability (resolution), see ["Thorough check of the area to be protected"](#), page 47

Recommendations for further thorough checks

In many cases, depending on the application conditions, the risk assessment of the machine determines that further thorough checks are required or that some thorough checks must take place more frequently.

In many cases, it makes sense to carry out the following thorough checks together with the regular thorough check:

- ["Visual check of the machine and the protective device"](#), page 48
- ["Test of the contour detection field"](#), page 48
- Test of the relevant points on the checklist, see ["Checklist for initial commissioning and commissioning"](#), page 108

In many cases, it makes sense to carry out the following thorough checks daily:

- ["Visual check of the machine and the protective device"](#), page 48
- ["Thorough check of the principal function of the protective device"](#), page 46

Complementary information

If the thorough check reveals an error, the machine should be shut down immediately. In this case, the mounting and electrical installation of the device must be checked by appropriately qualified safety personnel.

4.6.3 Notes on the tests

Thorough check of the principal function of the protective device

Recommended approach:

- ▶ Observe the status LEDs. A fault has occurred if at least one LED does not light up permanently when the machine is switched on.

- ▶ Test the function of the protective device. To do this, trigger the protective function once and observe the response of the safety outputs, for example based on the response of the machine.
 - Any application: During the test, observe whether the device indicates the detection within the protective field using the LEDs.
 - Stationary application (hazardous area protection, access protection, hazardous point protection):
 - Position the test object within the protective field and check whether the machine stops.
 - Mobile application (mobile hazardous area protection):
 - Place the supplied test object in the path of the vehicle and observe whether the vehicle stops.
 - OR
 - Activate a protective field in which at least one test object is located and check that the response is as expected (for example using an automatic test in the safety controller).

If the thorough check reveals an error, the machine should be shut down immediately. In this case, the mounting and electrical installation of the device must be checked by appropriately qualified safety personnel.

Thorough check of the area to be protected

The area to be protected and the detection capability are examined during this thorough check.

The thorough check covers the following points:

- Changes in the detection capability (thorough check of all configured fields)
- Modifications, tampering and damage to the protective device or the machine, which lead to changes in the area to be protected or the position of the protective field

Recommended approach for hazardous area protection:

- ▶ Position the supplied test object at a number of points at the edges of the area to be protected. The safety camera sensor must detect the test object at each position and indicate the detection. How it is indicated depends on the configuration. The number and position of sites where the thorough check is carried out must be chosen so that undetected access to the hazardous area is impossible.
- ▶ If a number of protective fields are used (in different monitoring cases for example), check the edges of all protective fields.
- ▶ Using the intended test object, check whether the distance of the protective field to the floor is within the required range. Perform this test along all lateral boundaries of the protective field.
- ▶ If a protective field extends to a wall or other mechanical barrier, use the intended test object to check whether the area between the protective field and the wall is of the required size and that it is not possible to step behind or reach behind at these points.

Recommended approach for access protection and hazardous point protection:

- ▶ Move the supplied test object along the edges of the area to be protected. The safety camera sensor must detect the test object at each position and indicate the detection. How it is indicated depends on the configuration. The protective field must be dimensioned such that reaching around or going around it is impossible.
- ▶ If a number of protective fields are used (in different monitoring cases for example), check the edges of all protective fields.

Recommended approach for mobile hazardous area protection:

- ▶ Place the supplied test object in the path of the vehicle and check whether the vehicle comes to a stop in time.

- ▶ If a number of protective fields are used (in different monitoring cases for example), check whether the vehicle comes to a stop in time in all of the protective fields.
- ▶ If necessary, change the position of the test object so that a thorough check is carried out for each monitoring case to determine whether the protective field is active over the whole of the required width.

If the thorough check reveals an error, the machine should be shut down immediately. In this case, the mounting and electrical installation of the device must be checked by appropriately qualified safety personnel.

Test of the contour detection field

The area to be protected and the detection capability are examined during this thorough check.

Recommended procedure:

- ▶ Position the supplied test object at a number of points at the edges of the area to be protected. The safety camera sensor must detect the test object at each position and indicate the detection. How it is indicated depends on the configuration.
- ▶ If several contour detection fields are used (for different monitoring cases, for example), check the edges of all contour detection fields.
- ▶ Using the test object provided, check whether the configured tolerance band has the required size and the dangerous state is ended in time.
- ▶ When used for fall protection: Slowly move the vehicle towards the floor opening (e.g., stair landing) and check whether the configured tolerance band has the required size and the dangerous state is ended in time.

If the thorough check reveals an error, the machine should be shut down immediately. In this case, the mounting and electrical installation of the device must be checked by appropriately qualified safety personnel.

ROI test

This test is used to test the safe distance check.

Recommended procedure:

- ▶ Move the object for which the ROI has been configured into the field of view and, if necessary, remove it from the field of view. The camera system must determine the distances correctly and switch the configured safety outputs according to the ROI tolerance band setting.
- ▶ Using an object (e.g. a cardboard box of sufficient size) between the contour and camera system, check whether the camera system switches the configured safety outputs according to the ROI tolerance band setting.

If the thorough check reveals an error, the machine should be shut down immediately. In this case, the mounting and electrical installation of the device must be checked by appropriately qualified safety personnel.

Visual check of the machine and the protective device

Recommended approach:

- ▶ Check whether the machine or the protective device has been modified or manipulated so that the effectiveness of the protective device may be impaired.
- ▶ In particular, check the following points:
 - Has the machine been retrofitted?
 - Have machine parts been removed?
 - Have modifications been made to the surroundings of the machine?
 - Are there any defective cables or flying leads?
 - Have the protective device or its parts been dismantled?
 - Is the protective device damaged?

- Is the protective device severely contaminated?
- Are the front screens contaminated, scratched or badly damaged?
- Has the protective device's alignment been changed?
- Are there any objects (e.g., cables, reflective surfaces) in the protective field?

If one of the points applies, the machine should be shut down immediately. In this case, the machine and the protective device must be checked by appropriately qualified safety personnel.

5 Mounting

5.1 Mounting the heat sink

Approach

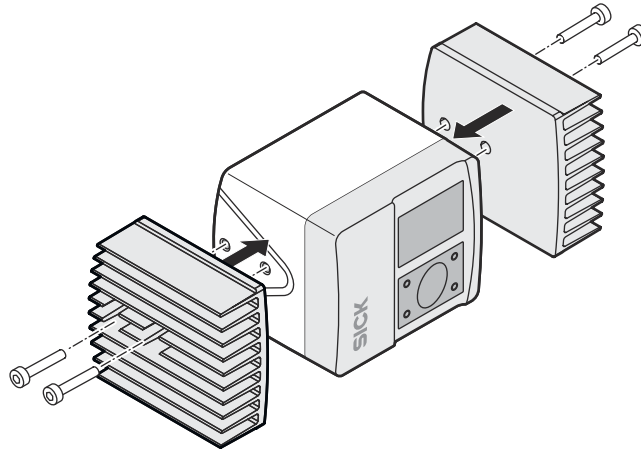

Figure 27: Mounting the heat sink

- ▶ Screw the heat sink into the M5 threaded holes located at the side.
- ▶ Maximum depth of engagement: 5.5 mm.
- ▶ Tightening torque: 2.5 Nm.
- ▶ In case of strong vibrations, use screw locking devices to secure the fixing screws.

Complementary information

If you are using heat sinks, then only the threaded holes on the bottom of the device are available for mounting.

Further topics

- ["Planning for mounting", page 22](#)
- ["Accessories", page 102](#)
- ["Dimensional drawings", page 99](#)

5.2 Mounting the device

Overview

You can use either the threaded holes at the sides or the threaded holes at the bottom of the device for direct mounting.

Prerequisites

- Project planning is completed.
- Assembly is carried out according to the project planning.
- Dangerous condition of the machine is and remains switched off during mounting.
- The outputs of the device do not affect the machine during mounting.

Approach

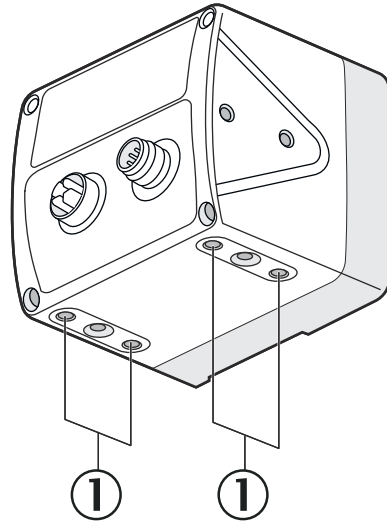

- ① M5 threaded mounting hole at the bottom

Direct mounting using the threaded holes at the bottom of the device

- ▶ Use all of the M5 threaded holes at the bottom of the device so the values given in the data sheet for vibration and shock resistance are achieved.
- ▶ Maximum depth of thread engagement: 7.5 mm.
- ▶ Tightening torque: 2.5 Nm.
- ▶ In case of strong vibrations, use screw locking devices to secure the fixing screws.

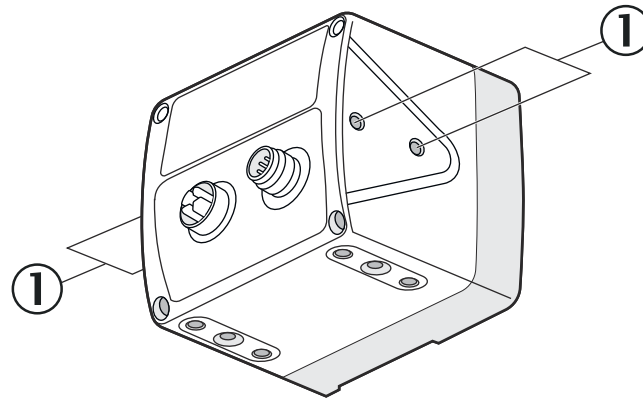

- ① M5 threaded mounting hole at the side

Direct mounting using the threaded holes at the sides

- ▶ Use all of the M5 threaded holes at the sides so the values given in the data sheet for vibration and shock resistance are achieved.
- ▶ Maximum depth of thread engagement: 5.5 mm.
- ▶ Tightening torque: 2.5 Nm.
- ▶ In case of strong vibrations, use screw locking devices to secure the fixing screws.

Complementary information

To facilitate mounting and alignment, SICK offers mounting kits as accessories.

Further topics

- ["Project planning", page 22](#)
- ["Accessories", page 102](#)

6 Electrical installation

6.1 System connection

Prerequisites

- Mounting is completed.
- Electrical installation is carried out according to the project planning.
- Electrical installation according to the requirements of integration in the electrical control system.
- Dangerous condition of the machine is and remains off during the electrical installation.
- Outputs of the device have no effect on the machine during electrical installation.
- Use shielded cables.

X2: System connection M12, 8-pin

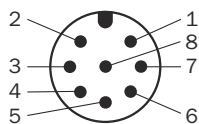

Figure 28: Male connector M12, 8-pin, A-coded

Table 21: Pin assignment M12, 8-pin

PIN	Designation	Description
1	+24 V DC	Supply voltage (24 V DC)
2	OSSD1.A	OSSD pair 1, OSSD A
3	0 V DC	Supply voltage (0 V DC)
4	OSSD1.B	OSSD pair 1, OSSD B
5	Uni I/O 1	<ul style="list-style-type: none"> • Universal I/O 1, configurable • Static control input (B) together with pin 8 • Parity evaluation 3 pins (P3.2) together with pin 7 and 8 • Parity evaluation 4 pins (P4.2) together with pin 6, 7 and 8
6	OSSD2.A Uni-I/O 2	<ul style="list-style-type: none"> • OSSD pair 2, OSSD A • Universal I/O 2, configurable • Static control input (A1) together with pin 7 • Parity evaluation 4 pins (P4.1) together with pin 5, 7 and 8
7	OSSD2.B Uni-I/O 3	<ul style="list-style-type: none"> • OSSD pair 2, OSSD B • Universal I/O 3, configurable • Static control input (A2) together with pin 6 • Parity evaluation 3 pins (P3.1) together with pin 5 and 8 • Parity evaluation 4 pins (P4.2) together with pin 5, 6 and 8
8	Uni-I/O 4	<ul style="list-style-type: none"> • Universal I/O 4, configurable • Static control input (B2) together with pin 5 • Parity evaluation 3 pins (P3.P) together with pin 5 and 7 • Parity evaluation 4 pins (P4.P) together with pin 5, 6 and 7
	FE	Functional earth/shield

Complementary information**Signals of the configurable universal I/O:**

- Universal input: resetting, EDM (external device monitoring), standby, restarting the device
- Universal output: contamination, fault, reset required, monitoring result

Further topics

- ["Project planning", Seite 22](#)
- ["Integration in the electrical control system", page 38](#)
- ["Mounting", Seite 50](#)
- ["Device overview", page 12](#)

6.2 Ethernet connection**Prerequisites**

- Dangerous condition of the machine is and remains off during the electrical installation.
- Outputs of the device have no effect on the machine during electrical installation.

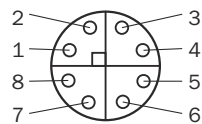
X1: Ethernet connection M12, 8-pin*Figure 29: Female connector, M12, 8-pin, X-coded**Table 22: Pin assignment*

PIN	Designation	Description
1	DA+	Data A +
2	DA-	Data A -
3	DB+	Data B +
4	DB-	Data B -
5	DD+	Data D +
6	DD-	Data D -
7	DC-	Data C -
8	DC+	Data C +
	FE	Shielding

Complementary information

The connection detects whether a crossover is required for the connection and selects an MDI configuration or MDI-X configuration accordingly.

Further topics

- ["Device overview", page 12](#)

7 Configuration

7.1 Delivery state

The device is not configured in the delivery state.

7.2 Safety Designer configuration software

The device is configured using the Safety Designer configuration software.

For information on the Safety Designer, see the operating instructions for the Safety Designer item no. 8018178.

7.2.1 Installing Safety Designer

Prerequisites

- Your Windows user account has rights for installing software.

Approach

1. Call up the download web page and enter **Safety Designer** in the search field on www.sick.com.
2. Take note of the system requirements on the download page.
3. Download the installation file from the download page. Extract it and run it.
4. Follow the notes from the setup assistant.

Complementary information

The SQL CE database is required to open legacy projects with the **.sdp** ending. When installing Safety Designer, you can select whether SQL CE should be installed for compatibility of legacy projects.



NOTICE

The SQL CE database is not a trustworthy source. The installation of untrustworthy sources may pose a safety risk.

- ▶ Only install SQL CE if you have to convert legacy projects.
-

7.2.2 Creating a project

Overview

Using Safety Designer, you can configure one or more devices in a project. You can save the configuration data in a project file on the computer.

Approach

- ▶ Click on **New project**.
- ✓ This creates and opens an empty project.

7.2.3 User interface

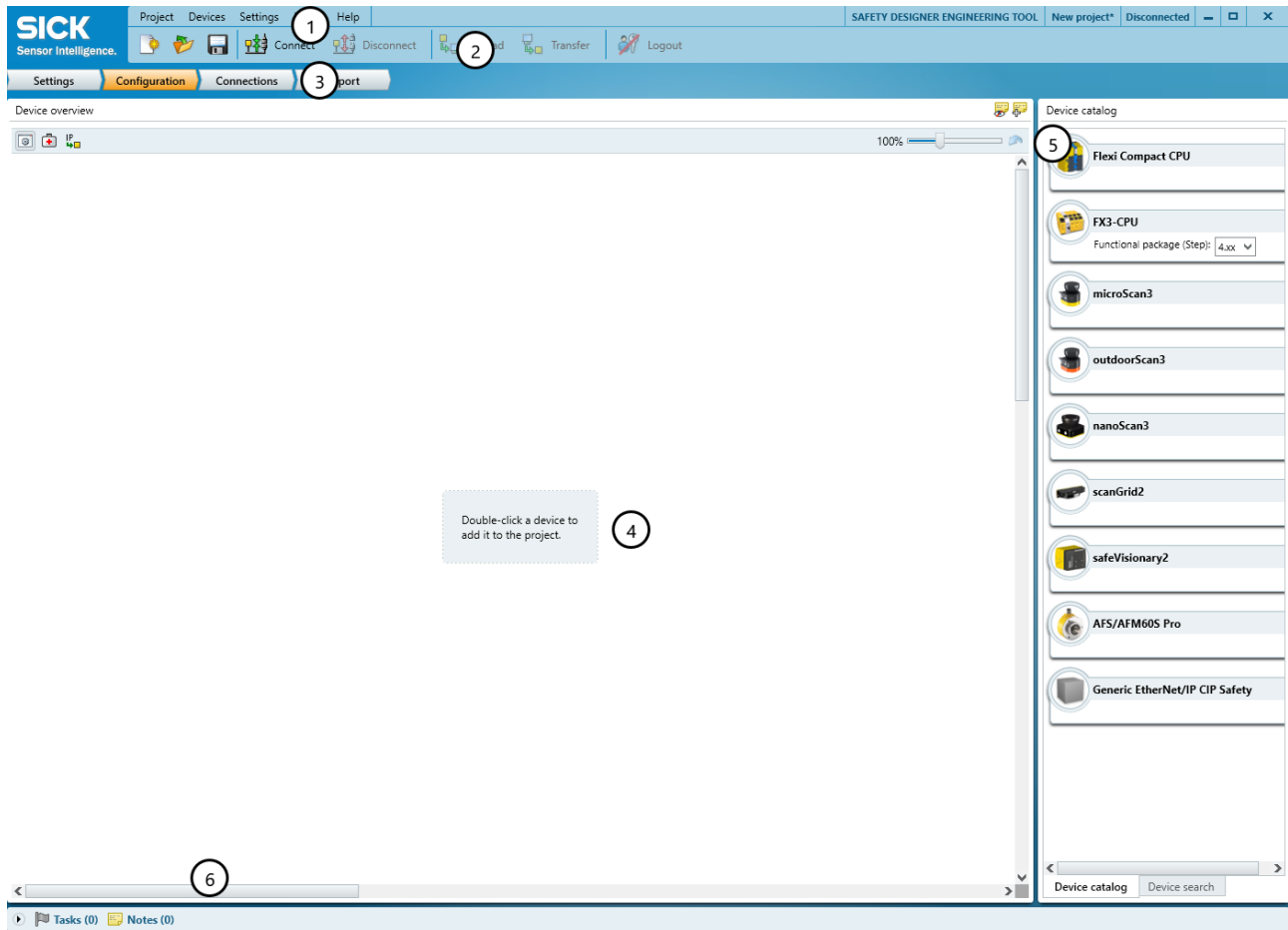

Figure 30: Software controls

- ① Menu bar
- ② Toolbar
- ③ Main navigation
- ④ Working range
- ⑤ Device catalog
- ⑥ Task list and notes

7.2.4 Configuring devices online

Overview

If devices are connected to a computer, Safety Designer can establish a connection to those devices. You then configure the devices online. In this case, you can transmit the configuration to the devices directly and use diagnostic functions.

Prerequisites

- Valid network address

Approach

- ▶ Click on **Connect**.
- ✓ Safety Designer searches for connected devices, with which it can establish a connection.

7.2.5 Configuring devices offline

Overview

If no devices are connected to the computer, select the devices from the device catalog. You then configure the devices offline. Diagnostics functions are not available.

You can connect the computer to the devices later, assign devices to the device tiles, and transfer the configuration to the devices.

Approach

1. In the main window, open the main navigation **Configuration**.
2. Add a device tile.

Further topics

- ["Add device tile", page 57](#)

7.2.6 User groups

Overview

The devices contain a hierarchy of user groups that regulate access to the devices.

For certain actions (e.g., transferring a configuration to the device), you are requested to log onto the device with the respective user group.

Important information



NOTICE

When you log into a device, the configuration software stores the password so that you do not need to re-enter it for other configuration steps.



If you do not change any other settings in the login dialog, the password is deleted as soon as you exit the configuration software, or log out in the main window or Device window.



If you enable the **Temporarily store password for login on additional devices.** function, the password will be retained even if you log out in the device window only.

If you leave the computer unattended, you must log off to prevent unwanted access to the device.

User groups

Table 23: User groups

User group	Password	Authorization
 Operator	No password required. Anyone can log on as a machine operator.	<ul style="list-style-type: none"> • May read configuration from the device.
 Maintenance personnel	Deactivated ex-works, i.e. it is not initially possible to log on as a maintenance technician. The user group can be activated by the user group administrator and provided with a password.	<ul style="list-style-type: none"> • May read configuration from the device. • May transmit verified configuration to the device. • Change own password allowed.

User group	Password	Authorization
 Authorized client	Deactivated ex-works, i.e. it is not initially possible to log on as an authorized customer. The user group can be activated by the user group administrator and provided with a password.	<ul style="list-style-type: none"> • May read configuration from the device. • May transmit verified and unverified configuration to the device. • May verify configuration. • Resetting the safety function and communication settings to factory defaults is allowed. • Change own password allowed. • Changing the password of the Maintenance personnel user group is allowed.
 Administrator	<p>The password SICKSAFE is created at the factory.</p> <ul style="list-style-type: none"> ▶ Change this password to protect the device against unauthorized access. 	<ul style="list-style-type: none"> • May read configuration from the device. • May transmit verified and unverified configuration to the device. • May verify configuration. • Resetting whole device to factory settings allowed. • Activating and deactivating device functions is allowed. • Activating and deactivating the Maintenance personnel and Authorized client user groups is allowed. • Change own password allowed. • Changing the passwords of the Maintenance personnel and Authorized client user groups is allowed.

7.3 Add device tile

Approach

The devices from the device catalog can be added to a project in the working range:

1. Open main navigation **Configuration**.
 2. Drag a device into the working range using drag and drop. Alternatively, double-click on a device in the device catalog.
- ✓ The device is shown as a tile in the working range.

Complementary information

When a device is configured offline for the first time, the device selection wizard opens for devices with multiple variants (device types). This is where you select the exact type of device to be configured.

7.4 Open the device window – configure devices

Overview

To configure the device, perform diagnostics or create reports, open a device window.

Approach

1. Double-click on the Device tile.
- ✓ The device window opens.

Complementary information

If you are configuring a device for the first time offline, the device window opens automatically as soon as you have selected the type of device to be configured.

7.5 Overview

Overview

You will find information on the safety camera sensor in the navigation **Overview**.

Project

- Project name
This name should be chosen the same for all devices in the project.
- Application name
This name can be the same for a number of devices in the project. It highlights that these devices realize an application together, by responding to one another for example.
- User name

Device information

Shows information about the device.

Connection status

Shows information about the connection and type of connection.

Checksums

A checksum is used as a unique identification for a configuration. Using the checksum, it is possible to work out whether a setup was changed or whether two devices have the same configuration.

The checksum of the configuration in the project may not match the checksum in the device, for example if a field geometry has been modified, but not yet transmitted to the device.

Table 24: Checksums of the safety camera sensor

Checksum	Components
Checksum of the configuration (function and network)	All adjustable parameters of the configuration, the device-specific depth maps, and the device-specific calibration data of the device.
Checksum of the configuration (function)	Adjustable parameters in the following areas: <ul style="list-style-type: none"> • Identification • Monitoring settings • Mounting setting • Fields and ROI • Inputs and outputs, local • Monitoring cases
Checksum of the configuration (function and network, without device specific data)	All adjustable parameters of the configuration without the device-specific depth maps and without the device-specific calibration data of the device.

System status

Shows information about the system.

Display

Shows the status of the LEDs when the device is connected.

7.6 Network settings

7.6.1 Ethernet

Ethernet

This is where you configure the IP settings to enable the device and computer to communicate via Ethernet.

Reading and transmitting values

If the values in the project and the values in the device differ, you can read the values out from the device and adopt them in the project. Alternatively, you can transmit values from the project to the device.

7.7 Reading configuration

Overview

At the left, you see the values configured in the project for the device. If the device is connected, you see the values saved in the device at the right.

If the values in the project and the values in the device differ, you can read the values out from the device and adopt them in the project.

Approach

1. Click on **Read from device**.
✓ The values are read from the device and adopted in the project.

Complementary information

Configuration:

- **Name**
If a number of devices are used in an application or in a project, a unique device name helps to tell the individual devices apart.
- **Checksums**
A checksum is used as a unique identification for a configuration. Using the checksum, it is possible to work out whether a setup was changed or whether two devices have the same configuration.
The checksum of the configuration in the project may not match the checksum in the device, for example if a field geometry has been modified, but not yet transmitted to the device.

7.8 Identification

Overview

On the **Identification** page, you can optionally enter attributes for the device. The attributes are used to identify the device or to distinguish between different devices. The attributes appear in reports and in the diagnostic data.

Device name

If a number of devices are used in an application or in a project, a unique device name helps to tell the individual devices apart.

Project name

The project name is used to identify an entire project. The same project name should be chosen for all devices in the project.

Application name

The application name can be the same for a number of devices in the project.

User name

The optional user name helps later users to find a contact for the application.

Application image

An image helps to identify the application more quickly. The application image is saved in the project file on the computer and transmitted to the device. The Safety Designer supports the following file formats: BMP, GIF, JPG, PNG, TIF.

Description

A description makes it easier to understand an application’s context more quickly.

7.9 Monitoring settings

Overview

The **Monitoring settings** page is used to configure general monitoring-related parameters.

The configured object resolution and multiple sampling initially apply to all fields. If necessary, you can change these settings for each individual field.

Resulting values are displayed in the area on the right. A graphic shows how the configuration affects the available scanning ranges.

Application type

The application type depends on the use of the safety camera sensor:

- **Stationary**
The position of the safety camera sensor is fixed. The safety camera sensor is used for hazardous area protection, hazardous point protection, or access protection.
- **Mobile**
In mobile applications, the safety camera sensor is mounted on the AGV (automatic guided vehicle). The safety camera sensor is used for mobile hazardous area protection, fall protection, or to protect against collisions.

Reference for increased scanning range

For stationary applications, you can activate an increased scanning range if the detection zone is limited by a visible background object, e.g., a wall.

The increased scanning range in mobile applications can affect the availability of the device.

If you activate the increased scanning range, then the **Body** object resolution is required.

Object resolution

The object resolution defines the size that an object must be to allow it to be reliably detected.

Table 25: Recommended object resolution

Application	Typical object resolution
Hazardous area protection	Body
Hazardous point protection	Hand, Arm
Access protection	Body
Mobile hazardous area protection	Leg, Body

Multiple sampling

Multiple sampling specifies how often an object has to be detected before the safety camera sensor responds. A higher multiple sampling reduces the possibility that insects, weld sparks or other particles cause the machine to be shut down. You will increase the machine's availability.

A higher multiple sampling setting increases the response time and affects the minimum distance, see "Response time", page 95.

Table 26: Recommended multiple sampling

Application	Recommended multiple sampling
Stationary application: such as horizontal hazardous area protection or vertical hazardous point protection under clean ambient conditions	2-fold
Stationary application: such as vertical access protection For vertical access protection with a narrow protective field in the direction of passage, only 1-fold, 2-fold or 3-fold multiple sampling must be used.	2-fold
Mobile application	4-fold
Stationary application: such as horizontal hazardous area protection under dusty ambient conditions	8-fold



NOTICE

In the case of 1-fold sampling, dust and other disturbances can lead to false shutdowns.

Measures to increase availability:

- ▶ Align the device towards a fixed background.
- ▶ Select a protective field that is only as large as necessary.
- ▶ Select the highest possible object resolution.
- ▶ Avoid retroreflectors in the field of view.
- ▶ Avoid laser sources (e.g., laser scanners) and other strong light sources in the detection zone.

Multiple sampling after switching between monitoring cases

When switching between monitoring cases, it is possible that a person may already be in the newly activated protective field when switching takes place. To ensure that the person is detected quickly and the dangerous state is brought to an end swiftly, you can adjust the multiple sampling (n) setting immediately after switching between monitoring cases – regardless of any other multiple sampling in place.

For persons and body parts to be reliably detected, each monitoring case must be active for at least as long as the device requires for detection.

- **Fast (default)**
Multiple sampling after switching between monitoring cases $n_{CS} = 1$. An object must be detected once, then the safety camera sensor responds. Fastest response of the safety camera sensor. False shutdowns can occur in the event of interference at the time of monitoring case switching.
- **Reliable**
Multiple sampling after monitoring case switching $n_{CS} = n - 1$, min. 1. Multiple sampling after switching between monitoring cases is one detection fewer than any other multiple sampling in place. This reduces the possibility that insects, weld sparks, or other particles cause the machine to be switched off. This increases machine availability. The standard response time applies from the outset in the new field.

- **User defined**
You can adjust the settings for multiple sampling after switching between monitoring cases in line with your requirements for the response time and reliability. Regardless of the exact settings here, multiple sampling after switching between monitoring cases is always at least one detection fewer than any other multiple sampling in place: $n_{CS} \leq n - 1, \text{min. } 1$.

Multiple sampling after object detection

After an object is detected, the protective field must be detected as unobstructed at least four times in succession before the safety outputs switch back to the ON state.

If you activate the **Activate different multiple sampling after object detection** option, you can specify alternate values for the monitoring level or for individual fields. This may cause the outputs to switch back to the ON state faster or slower after a field has become free again.

Further topics

- "Response time", page 95
- "Planning for mounting", page 22

7.10 3D editor

Overview

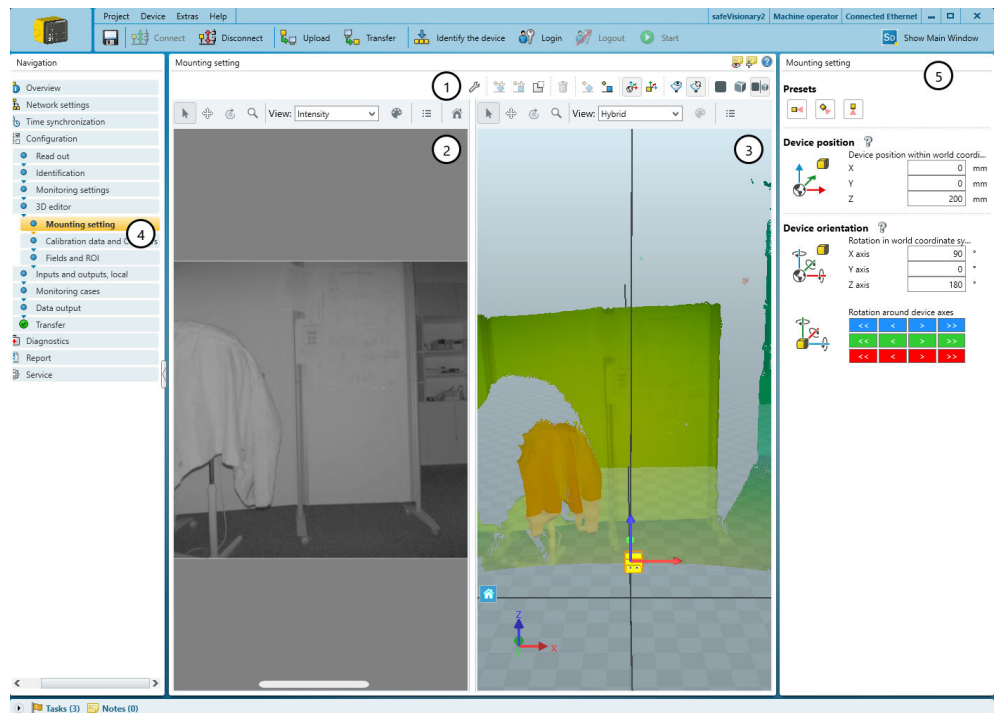

Figure 31: 3D editor

- ① Toolbar
- ② 2D view
- ③ 3D view
- ④ Main navigation: Mounting setting, Calibration data and Contours, Fields and ROI
- ⑤ Depending on the selected main navigation: Adjust the mounting settings, manage calibration data/contours, or configure fields/ROIs

In the 3D Editor, you can adjust the mounting settings, manage calibration data and contours, and configure fields or field sets and ROIs or ROI sets.















The 2D view shows the captured scene from the point of view of the camera sensor. You can use the 2D view to position the camera sensor and configure the ROIs.

The 3D view shows the camera sensor within the room. You can use the 3D view to position the camera sensor and configure the fields.

Live data can be displayed if the camera is connected.





3D Editor toolbar





Table 27: Buttons on the toolbar

Button	Function
	Show 2D view and 3D view in parallel
	Show 3D view only
	Show 2D view only
	Display live measurement data
	Show snapshot of the measurement data. Clicking again clears the measurement data shown.
	Show and hide the grippers for rotating about the axes of the device coordinate system
	Show and hide the grippers for displacing along the axes of the world coordinate system
	Align selected object to the floor
	Align selected object to the camera system
	Delete selected geometries
	Mask areas
	Create cuboid, aligned to the floor
	Create cuboid, aligned to the camera system
	Field editor settings
	Calculate field sets

Toolbar in the 2D view and 3D view

Table 28: Buttons on the toolbar

Button	Function
	Arrow tool, select objects
	Shift perspective
	Rotate perspective
	Zoom tool Press and hold the left mouse button and move the mouse up (enlarge image section) and down (reduce image section).

Button	Function
View	Select view
	Color settings
	Select options to show or hide in the view
	Reset view (2D view only)
	Rotate clockwise (2D view only)

7.10.1 Adjusting the mounting settings

Overview

The **Mounting setting** page is used to specify the position of the device within the room. The setting should correspond to the real position and orientation of the camera sensor relative to a surrounding structure or a reference surface (e.g., the floor). This makes it easier to interpret the 3D scene and to configure the protective fields in relation to the surroundings. You can adjust the mounting settings either using the input fields on the right or directly within the 3D view.

Approach

Adjusting the mounting settings via the input fields

1. On the right in the **Presets** area, select a preset for the sensor position.
2. In the **Device position** area, enter the exact X, Y and Z values for the sensor position in the world coordinate system.
3. In the **Device orientation** area, set the sensor orientation. The following options are available for this:
 - o Rotation in world coordinate system:
Rotates the device around the axes of the world coordinate system by adjusting the X, Y and Z values
 - o Rotation around device axes
Rotates the device around the device axes by making adjustments using the arrows

Adjusting the mounting settings directly within the 3D view

1. On the right in the **Presets** area, select a preset for the sensor position.
2. In the toolbar for setting the sensor position, select the following icon.

	Show/hide handles for displacement along the axes of the world coordinate system.
---	---

- ✓ The handles for moving the sensor are displayed.
- 3. Position the mouse on the arrowhead of an axis.
- ✓ The arrowhead of the axis turns yellow.



4. Click on the yellow arrowhead using the mouse. Hold down the mouse and move the sensor to the correct position on the axis.
5. Repeat steps 3 and 4 for the other two axes.
6. In the toolbar for setting the sensor orientation, select the following icon.

	Show/hide handles for rotation about the device axes.
---	---

- ✓ The handles for rotating the sensor are displayed.
- 7. Position the mouse on the arc of an axis.
- ✓ The arc turns yellow.



8. Click on the yellow arc using the mouse. Hold down the mouse and rotate the sensor around the axis.
9. Repeat steps 7 and 8 for the rotation about the other two axes.

Complementary information

Axis colors:

- X-axis: Red
- Y-axis: Green
- Z axis: Blue

Further topics

- ["Coordinate system", page 14](#)

7.10.2 Calibration data and Contours

Overview

The **Calibration data and Contours** page can be used to do the following:

- Manage calibration data
- Teach-in and manage reference contours

Calibration data

For each safety camera sensor, calibration data is retrieved from the device and offset against the fields to be configured.

Reference contours

A reference contour is created from several image acquisitions and is required for proper functioning of contour detection fields.

You can use the same reference contour for multiple devices. When transferring the reference contour to another device, minor deviations in the reference contour may occur due to the conversion to the device-specific calibration data of the destination device. If the configured tolerance zone is too small or the reference environment is strongly contoured, then this can lead to erroneous shutdowns. In this case, increase the tolerance zone or teach-in the reference contour again using the device.

If you use a reference contour that has been taught-in on another device, then you must check whether a test object in direct contact with the reference contour is reliably detected.

Buttons on the calibration data toolbar

Table 29: Buttons on the calibration data toolbar

Button	Function
	Add device calibration data
	Add reference contour
	Delete element
	Activate the selected calibration data and calculate fields for this device

Button	Function
	Shows fields that use the reference contour

7.10.3 Fields and ROI

The **Fields and ROI** page is used to configure the fields and ROIs of the device.

7.10.3.1 Fields

Overview

In the **Fields** area, you create the field sets and fields. In the area below that, you can set the properties of the fields and field sets.

In the 3D Editor, you can add cuboids for selected fields of a field set via the toolbar. Depending on the selection, the cuboid is aligned parallel to the device or parallel to the floor.

You can adjust the position and orientation of a cuboid using the grippers in the 3D editor or in the field settings.

Important information



WARNING





Ineffectiveness of the protective device due to positioning of the protective field outside the limited field of view

Areas of the protective field that lie outside the limited field of view are automatically removed. The monitoring function has no effect in these areas. The dangerous state may not be stopped or not be stopped in a timely manner in the event of non-compliance.

- ▶ Place protective fields within the limited field of view.
- ▶ Check that the protective field has a minimum size of 300 mm in each direction within the limited field of view.

Buttons on the Fields toolbar

Table 30: Buttons on the Fields toolbar

Button	Function
	Add field set
	Add field to field set
	Duplicate field set
	Delete field or field set
	Hide or show field sets and fields

Properties of the fields and field sets

Table 31: Properties of the fields and field sets

Features	Description
Name	You can assign a unique name to each field.
Field type	Shows the selected field type.

Features	Description
Multiple sampling Object resolution	At first, the object resolution and multiple sampling configured for the monitoring plane apply for all fields. If necessary, you can change these settings for each individual field. For the contour detection field, sizes for openings in the floor are also available when selecting the object resolution. The safety camera sensor ignores gaps (openings) in the contour up to a certain size. The cut-off path switches to the OFF state if the opening exceeds the configured size. If you have activated the Reference for increased scanning range setting, then only the 100x100 cm object resolution for floor openings is available.
Contour detection field Reference contour	The safety camera sensor monitors a specific area in its surroundings. This requires a reference image of the surroundings (reference contour). The monitored area is the area of intersection between the contour of the reference image and the projection of the field geometry onto the reference contour. You can assign a separate reference contour for each contour detection field here. The Calibration data and Contours page can be used to create the reference contours.
Contour detection field Tolerance band	A contour has a positive and a negative tolerance band. The cut-off path switches to the OFF state if the safety camera sensor does not detect the contour within the tolerance band. <ul style="list-style-type: none"> • Positive tolerance (far): The tolerance away from the safety camera sensor • Negative tolerance (near): The tolerance toward the safety camera sensor <p>Note "Properties of tolerance band for contour detection fields", page 67</p>
Partial checksum (field geometry)	Shows the partial checksum for field geometries.

Properties of tolerance band for contour detection fields

- To reliably detect an object, the distance values of the object must differ from the reference contour by more than the configured tolerance band. With the default setting, the tolerance band reliably detects the selected object resolution, even if the object is in direct contact with the reference contour.
- A smaller tolerance band can lead to unintended shutdowns of the machine due to vibrations, measurement noise or thermal effects. Use a smaller tolerance band only in exceptional cases, and in that case set a multiple sampling of 4x or higher.
- A larger tolerance band may result in an object not being reliably detected if it is in direct contact with the reference background. Check for consistent detection using a dark test object of the same size. If the tolerance band is too large, either reduce the value of the tolerance band or use other measures to prevent relevant objects in direct contact with the reference contour from entering the hazardous area.

Minimum field geometry size

Table 32: Minimum cuboid size

Object resolution	Minimum cuboid size (W x D x H)
Hand Arm Leg Body	300 mm × 300 mm × 300 mm
40x40 cm (contour detection field)	400 mm × 400 mm × 400 mm
100x100 cm (contour detection field)	1,000 mm × 1,000 mm × 1,000 mm

Further topics

- ["Monitoring cases", page 73](#)
- ["Field types", page 16](#)
- ["Field of view", page 12](#)
- ["Calibration data and Contours", page 65](#)

7.10.3.1.1 Drawing in points that cannot be monitored**Overview**

Objects in the room, for instance supporting pillars, partition grids, etc., create areas that the device cannot monitor.

You draw objects that limit the field of view of the device as masked areas.

Table 33: Mask areas

	Mask areas
---	------------

Important information**WARNING**

Ineffectiveness of the protective device

When drawing in the areas that cannot be monitored, the protective field may be smaller than the required minimum size. The monitoring function cannot be ensured in this case. The dangerous state may not be stopped or not be stopped in a timely manner in the event of non-compliance.

- ▶ Check that the protective field still has a minimum size of 300 mm in each direction after drawing in the areas that cannot be monitored.

Approach

1. Click on the **Mask areas** tool.
2. Create a cuboid and use it to draw the masked area.
- ✓ The cuboids are shown in gray.

Complementary information

The masked areas are only shown in the 3D view.

7.10.3.1.2 Defining global geometry**Overview**

You draw field geometries and non-monitored areas as global geometry. The global geometry affects all protective fields and warning fields.

Table 34: Defining global field geometry

	Edit field editor settings
---	----------------------------

Approach

1. Click on the **Edit field editor settings** tool.
2. Activate the **Globale Geometrie** checkbox.
3. In the **Fields and ROI (Regions of Interest)** area, select > **Globale Geometrie**.
4. Select the cuboid and use it to draw the global field geometry.
5. If applicable, draw non-monitored areas with the **Mask areas** tool.

7.10.3.2 ROIs (region of interest)

Overview

The ROIs area is used to create ROI sets and ROIs. In the area below that you can set the properties of the ROIs and ROI sets and position the ROIs. You can also position the ROIs directly in the 2D view. An ROI has a size of 10 pixels × 10 pixels.

Important information



NOTE

The 2D view is rotatable. When positioning the ROIs using the 2D view, use the real scene and the x and y values to check that the position is correct.

Buttons on the ROI toolbar

Table 35: Buttons on the ROI toolbar

Button	Function
	Add ROI set
	Add ROI to ROI set
	Duplicate ROI set
	Delete ROI or ROI set
	Hide or show ROI or ROI set

Properties of the ROIs and ROI sets

Table 36: Properties of the ROIs and ROI sets

Features	Description
Name	You can assign a unique name to each ROI.
Field type	Shows the selected field type.
ROI Measurement Value Output	Outputs the average of the measured values.
Average Filter	You can use the Average Filter property to specify the number of measured values used to calculate the average value.
ROI Tolerance	The cut-off path switches to the OFF state if the measured value is not within the tolerance band. Multiple sampling: The multiple sampling configured for the monitoring level initially applies to all ROIs. You can adjust this setting individually for each ROI if necessary.

Further topics

- ["Monitoring cases", page 73](#)
- ["Region of interest \(ROI\)", page 17](#)

7.11 Inputs and outputs, local

Overview

You will find an overview of the connections of the safety camera sensor on the **Inputs and outputs, local** page.

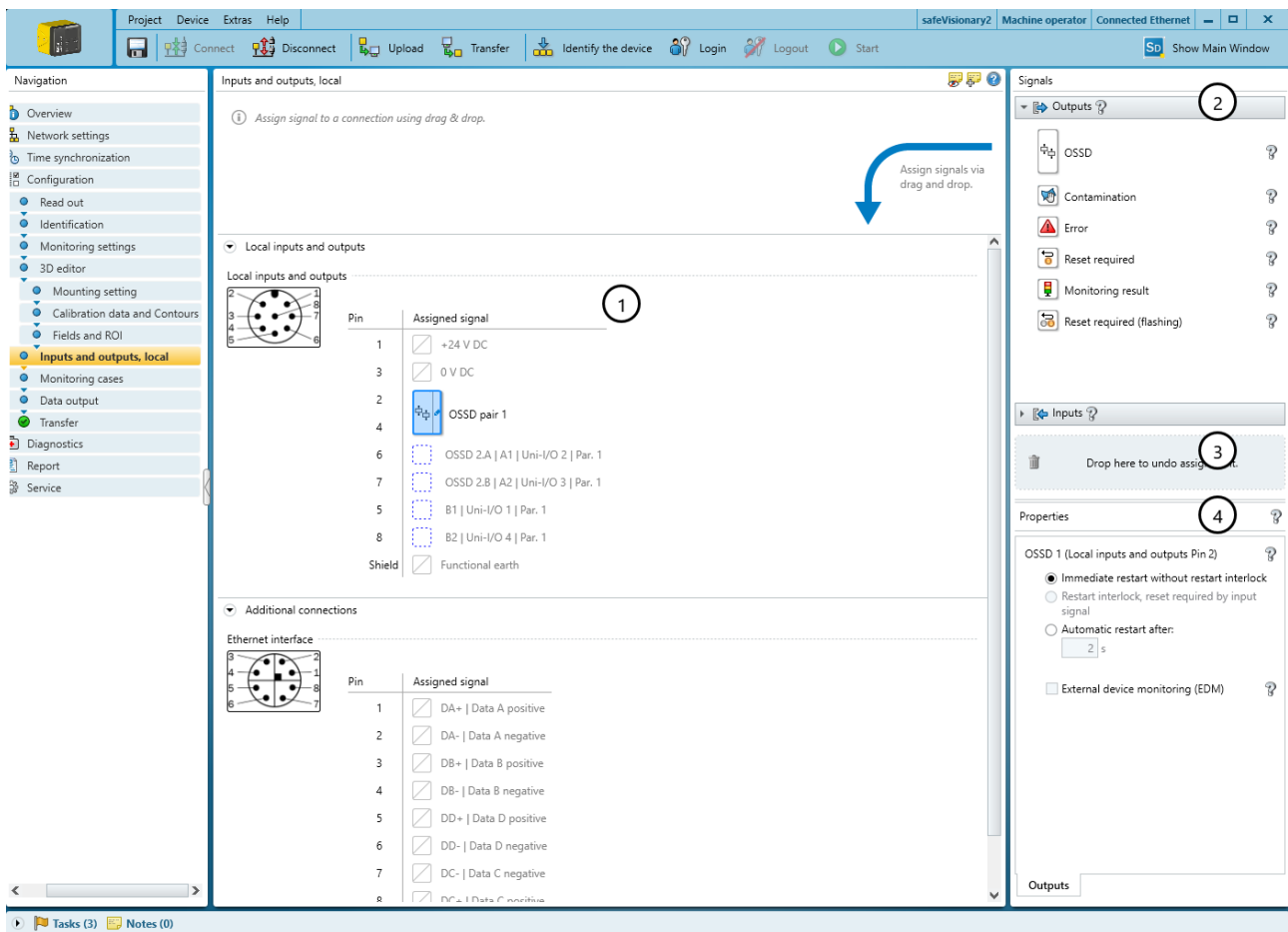

Figure 32: Inputs and outputs, local

- ① Pin assignment
- ② Available signals
- ③ Remove signal from connection
- ④ Further settings for some signals

7.11.1 Output signals

OSSD

Dual-channel, safety switching output which is used to switch off the dangerous state.

Contamination

Signals that the front screens are contaminated.

- **Partial contamination, optical covers should be cleaned soon (contamination warning).** setting: The front screens should be cleaned soon.
- **Heavy contamination, device switches to the OFF state (contamination error).** setting: All safety outputs are in the OFF state. The front screens are heavily contaminated and must be cleaned immediately.

Error

Indicates an error.

- **Device error** setting: Device faults are serious errors where all safety outputs switch to the OFF state and the device changes to the interlocked state. Once the cause of the error has been rectified, the device must be completely restarted.
- **Application error** setting: In the event of an application error, all safety outputs switch to the OFF state. Once the cause of the error has been rectified, the safety function must be restarted.

Reset required

Signals that a reset is possible. A connected lamp lights up if the restart interlock has been triggered and the protective field is then clear again.

Monitoring result

Indicates the status of the active field. A connected lamp lights up if an object is detected in the field.

Reset required (flashing)

Signals that a reset is possible. A connected lamp flashes if the restart interlock has been triggered and the protective field is then clear again.

7.11.2 Input signals

Static control input

Signal of the machine controller for switching between monitoring cases.

Evaluation methods: Complementary evaluation, 1-out-of-n evaluation

Parity evaluation (3 pins), Parity evaluation (4 pins)

Signal of the machine controller for switching between monitoring cases.

Evaluation methods: Parity evaluation (odd, even)

External device monitoring (EDM)

Signal from the auxiliary contacts of the positively guided contactors for external device monitoring (EDM).

Reset

Signal from the reset pushbutton to manually reset the internal restart interlock.

Sleep mode

Signal from a pushbutton to activate sleep mode.

Restart device

Signal from a pushbutton to completely restart the device.

Pause event recording

Signal of a pushbutton to stop the event history.

7.11.3 Further settings for some signals

Restart interlock for the OSSD pair

The following options are available for the restart behavior of the OSSDs:

- **Immediate restart without restart interlock:** If there is no longer an object in the protective field, the device switches the OSSDs to the ON state.
- **Restart interlock, reset required by input signal:** If the operator activates the restart or reset control switch, the device switches the OSSDs to the ON state.
- **Automatic restart after::** If there is no longer an object in the protective field, the device switches the OSSDs to the ON state after the configured delay.

External device monitoring (EDM)

An input must be configured for external device monitoring (EDM). This input must be correctly connected to the electrical control system.

If external device monitoring is activated, the device checks whether voltage is applied at the external device monitoring (EDM) input after the OSSDs have been switched off.

If no voltage is applied at the input after the OSSDs have been switched off, the device changes to the interlocked state and does not switch the OSSDs back to the ON state.

Signal level

For some non-safe output signals, you can select whether the signal is output with HIGH or with LOW:

- **Setting Hi:** The output is normally in LOW state. If the signal is active, the output switches to HIGH state.
- **Setting Lo:** The output is normally in HIGH state. If the signal is active, the output switches to LOW state.

7.12 Monitoring cases

Overview

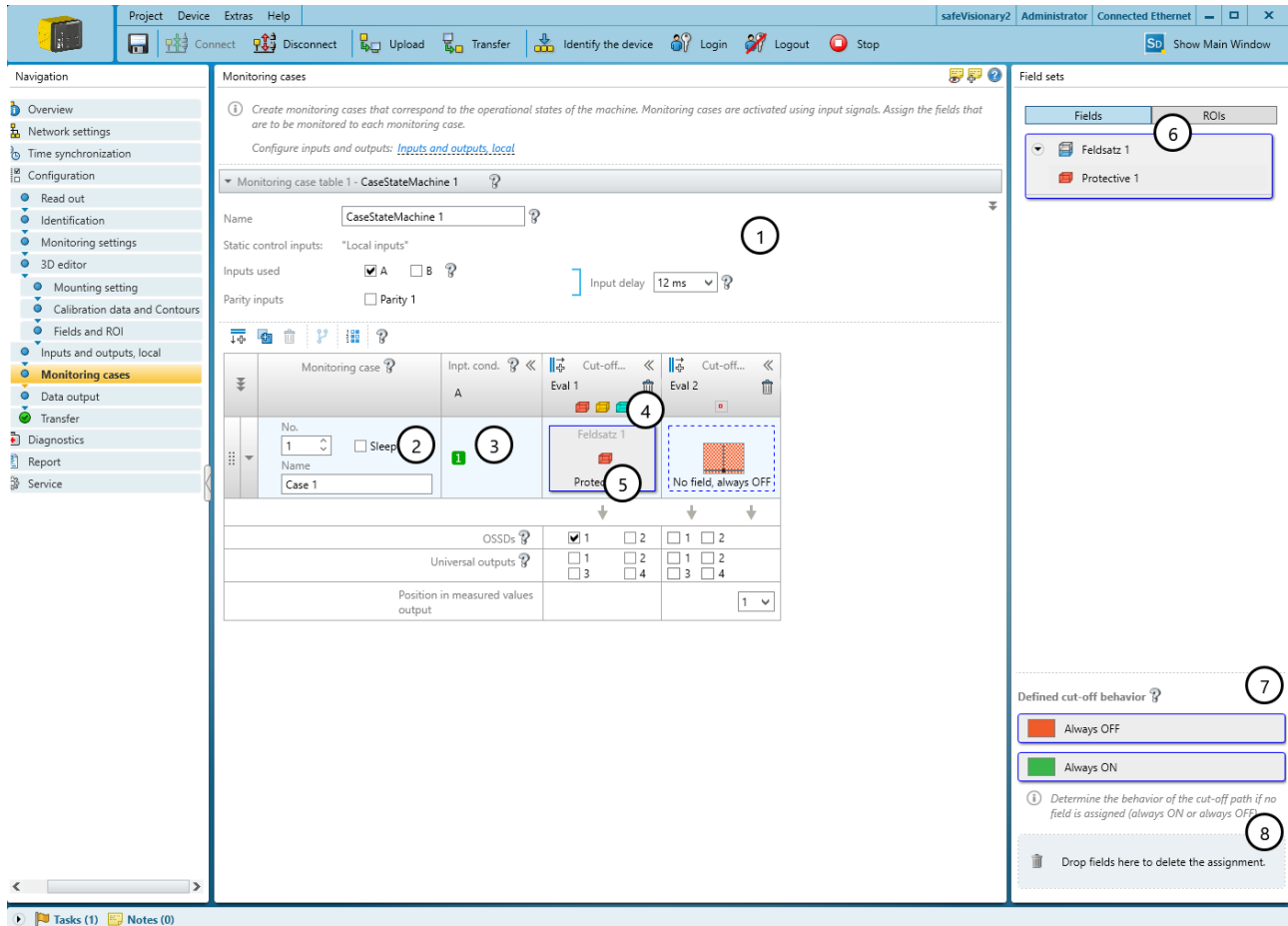

Figure 33: Monitoring cases

- ① Settings for the whole monitoring case table
- ② Settings for the individual monitoring case
- ③ Input conditions for a monitoring case
- ④ Field set in the monitoring case and in the cut-off path
- ⑤ Cut-off paths for fields and ROIs
- ⑥ Configurable field sets and ROI sets
- ⑦ Areas for defined cut-off behavior
- ⑧ Remove field set from a monitoring case

In the monitoring case editor, you can also define the monitoring cases with input conditions and assign the field sets/ROI sets.

7.12.1 Settings for monitoring case tables

Name

In the **Name** field, you can enter a meaningful name for the monitoring case table.

Inputs used

You choose the inputs that you would like to use for switching between monitoring cases in the monitoring case table.

Input delay

In the **Input delay** field, you can select a delay for the inputs.

If the control device that you use to switch the static control inputs or parity inputs cannot switch to the appropriate input condition within 12 ms (for example because the stable output state is not achieved until later), you must configure an input delay. The selected input delay must be large enough to allow your control device to switch to the new input condition within this time.

Table 37: Empirical values for the required input delay

Switching method	Input delay required
Electronic switching via a controller, parity evaluation, 1 out of n or complementary electronic outputs with 0 ms to 12 ms bounce time	12 ms
Tactile controls (relays)	30 ms ... 150 ms
Control via independent sensors	130 ms ... 480 ms

Further topics

- ["Timing for monitoring case switching", page 26](#)
- ["Static control inputs, Parity inputs", page 41](#)

7.12.2 Settings for monitoring cases

Name

In the **Name** field, you can enter a meaningful name for the monitoring case. If you create a lot of monitoring cases, you should consider a naming concept that makes it possible to identify the monitoring cases easily (for example right cornering, left cornering).

Sleep mode

If you activate this option, the device changes into sleep mode as soon as the input conditions for this monitoring case exist.

7.12.3 Defining input conditions

Overview

For each monitoring case, you choose the input conditions for which the monitoring case will be activated.

Prerequisites

- The inputs that are in use are selected.

Approach

- ▶ Static control inputs: In the **Input condition** column, click on the fields with the input conditions (1, 0 or any) until the desired condition is displayed for each input and each monitoring case.
- ▶ Parity inputs: Select the input condition in the drop-down menu.
- ✓ The input conditions for the monitoring cases are now defined. Combinations which are invalid or already assigned are marked.

7.12.4 Configuring cut-off paths

Overview

You can create cut-off paths and define the outputs switched by the cut-off paths.

You need a cut-off path for every field in a field set and for every ROI in an ROI set. If the field sets/ROI sets have different sizes, use the field set/ROI set with the most fields/ROIs as a guide.

Approach

1. Click on the **Add cut-off path** button.
2. If applicable, enter a meaningful name for each cut-off path.
3. Select the outputs that the cut-off path should switch.

7.12.5 Assigning field sets and ROI sets

Overview

On the right in the **Field sets** area, the created field sets are listed under **Fields**.

The created ROI sets are listed under **ROIs**.

Approach

Assign a field set/ROI set to a monitoring case.

- ▶ Assign a field set/ROI set to a monitoring case using drag and drop.

Assigning a field/ROI to a monitoring case

- ▶ Assign a field set/ROI set to a monitoring case using drag and drop.
- ▶ Right click on the assigned field set/ROI set and select **Split field set/Split ROI set**.
- ▶ Assign the individual fields/ROIs to a monitoring case using drag and drop.

Removing assignment

- ▶ Drag a field set/ROI set or field/ROI from a monitoring case onto the trash can icon.

7.12.6 Assigning a defined cut-off behavior

Overview

In a monitoring case, you can assign a defined cut-off behavior to a cut-off path instead of a field:

- **Always OFF:** If the monitoring case becomes active, the cut-off path is in the OFF state.
- **Always ON:** If the monitoring case becomes active, the cut-off path is in the ON state.

Approach

Assigning a defined cut-off behavior

- ▶ Assign a cut-off behavior to a cut-off path in a monitoring case using drag-and-drop.

Complementary information

If you have not assigned fields to certain cells in a monitoring case table, Safety Designer automatically assigns the **Always OFF** function to these cells.

7.12.6.1 Defining permanent default settings

Overview

With this function, you can define specified cut-off behaviors per cut-off path as default settings for monitoring cases.

Table 38: Show/Hide permanent presets

	Show/Hide permanent presets
---	-----------------------------

Approach

- ▶ Select **Show/Hide permanent presets**.
- ✓ Safety Designer displays an additional line in the monitoring case table.
- ▶ Assign a cut-off behavior to a cut-off path in the **Permanent preset** cell using drag and drop.
- ✓ Safety Designer applies the default settings when you add a new monitoring case.

7.13 Data output

Overview

Data output can be used for general monitoring and control tasks. This data is used in particular for providing navigation support for AGVs (automated guided vehicles). This data must not be used for safety-related applications.

Send Mode

- **Deactivated:** No data output
- **Continuously to a target computer (router settings are configured via "Network settings"):** Data output continuously or at every xth measurement via UDP to a defined destination address

Data content selection

Data content:

- Complete: All data will be output.
- Reduced: The intensity values are left out.
- Only ROI: Only the ROI data is output.

Data content selection

- Filtered measurement data
The measurement data is pre-filtered. Noise and measurement artifacts are reduced.
- Unfiltered measurement data
The unfiltered measurement data is output.

Complementary information

For additional information on data output, see the technical information “safeVisionary2: Data output via UDP and TCP/IP” (part number 8027548).

7.14 Transferring a configuration

Overview

A configuration is first saved in your Safety Designer project as a configuration file. You transfer the configuration to the connected device.

At the left, you see the values configured in the project for the device. If the device is connected, you see the values saved in the device at the right.

The compatibility of the configuration is checked during transmission. An existing configuration on the device is overwritten.

Approach

1. Check the configuration carefully before transmission.
 2. Click on **Identify the device** to ensure that the desired device is connected.
 3. If the checksums on the computer and the device differ, click on **Transfer to device**.
- ✓ Safety Designer displays the transfer process.

Complementary information

A checksum is used as a unique identification for a configuration. Using the checksum, it is possible to work out whether a setup was changed or whether two devices have the same configuration.

The checksum of the configuration in the project may not match the checksum in the device, for example if a field geometry has been modified, but not yet transmitted to the device.

7.15 Verify configuration

Overview

By verifying the configuration, you can confirm that the configuration complies with the planned safety function and fulfills the requirements in the risk assessment.

During verification, Safety Designer reads back the configuration transferred to the device. It compares the configuration with the configuration saved in Safety Designer. If both configurations are identical, Safety Designer displays the verification report. If the user confirms that this is correct, the system is considered to be verified.

Important information



DANGER

Hazard due to lack of effectiveness of the protective device

Errors can occur when transferring the configuration to the device, e.g., due to environmental influences or faulty cables. The verification report always contains exactly the settings that are stored in the device.

- ▶ Before confirming, check the verification report carefully.

Prerequisites

- The configuration corresponds to the planned safety function and meets the requirements of the risk assessment.
- The configuration has been transferred to the device.

Approach

1. Click on **Verify**.
 - ✓ Safety Designer displays the verification report.
2. Thoroughly review the verification report.
 - ▶ If the verification report does not match the planned safety function, click on **Cancel**, correct the configuration and start again from step 1.
 - ▶ If the verification report matches the planned safety function, click on **OK**.
- ✓ Device configuration is shown as verified.

Complementary information

If the configuration is verified, the device automatically starts the safety function after switching on the voltage supply.

If the configuration is not verified, the device may not be operated as a protective device. You can start the safety function manually to test the device and the configuration. The test operation has a time limit.

Further topics

- ["Starting and stopping safety function", page 78](#)

7.16 Starting and stopping safety function

Overview

In some situations, for example tests during commissioning, you can start or stop the safety function manually.

Approach

Start safety function

- ▶ Click on the  button.

Stop the safety function

- ▶ Click on the  button.

7.17 Report

Overview

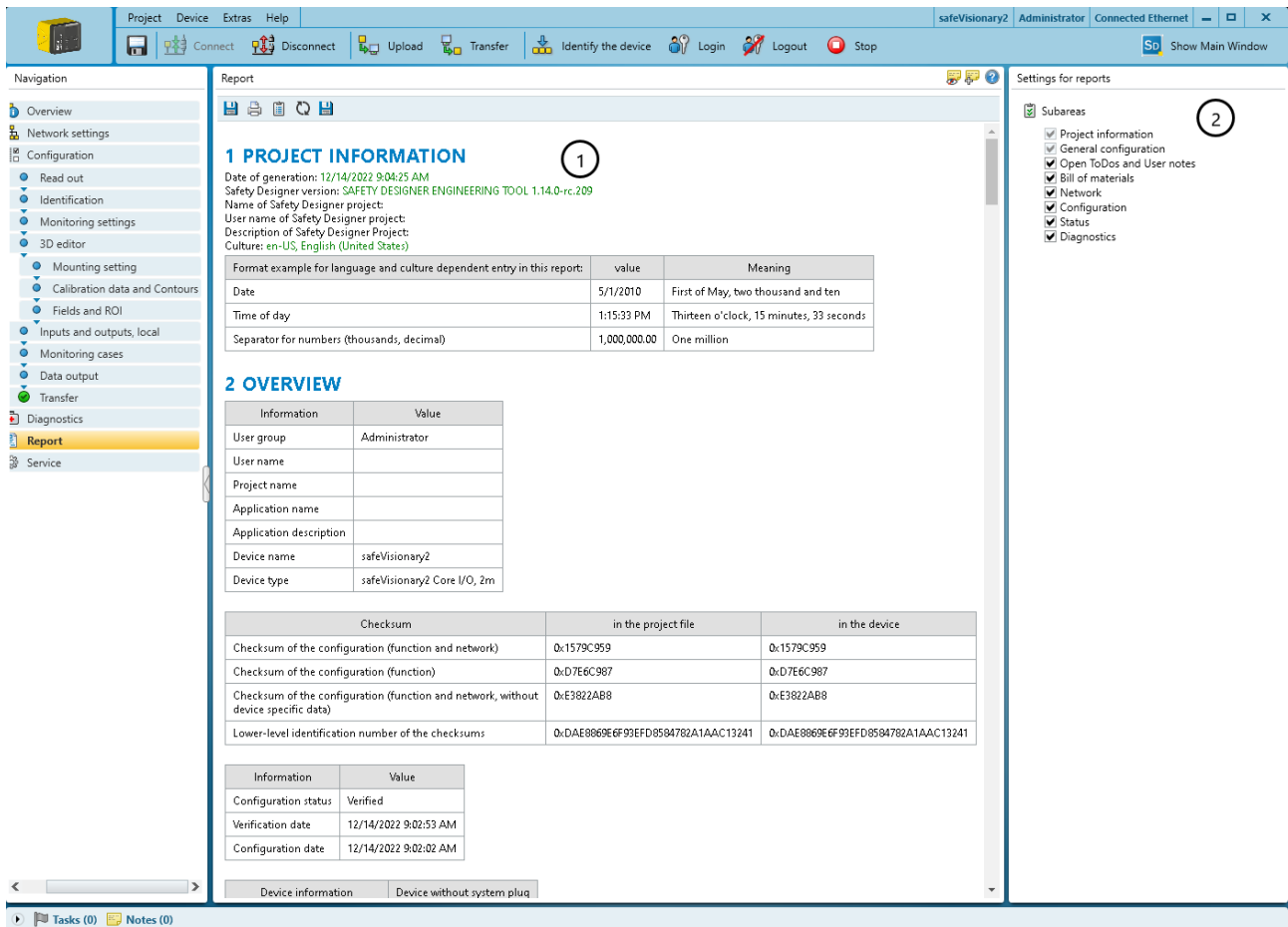

The screenshot shows the safeVisionary2 software interface. The main window displays the 'Report' section, which is divided into two main parts: '1 PROJECT INFORMATION' and '2 OVERVIEW'. The '1 PROJECT INFORMATION' section includes a date of generation, safety designer version, and project name. Below this is a table with columns for 'Format example for language and culture dependent entry in this report', 'value', and 'Meaning'. The '2 OVERVIEW' section contains two tables: one for 'Information' and 'Value' (listing user group, name, project name, application name, description, device name, and type), and another for 'Checksum' (comparing checksums in the project file and in the device). A third table shows 'Configuration status' and dates. On the right side, the 'Settings for reports' pane is visible, with a list of subareas and their corresponding checkboxes. Two callouts are present: callout 1 points to the '1 PROJECT INFORMATION' section, and callout 2 points to the 'Settings for reports' pane.

Figure 34: Report

- ① Content of the report
- ② Composition of the report

A report shows the settings and data of a device. You have the option of saving and archiving these data as a PDF.

Report

When you open the **Report** dialog box, the Safety Designer creates a report. If you click on **Update** after making changes to the configuration, you will receive an updated report.

Composition of the report

You can assemble the contents of the report as required.

Complementary information

National and international standards promote or recommend specific data and the person responsible for it. The required data are included in the report.

7.18 Service**Overview**

You can run the following under service:

- Reboot device
- Reset the device to factory settings
- Managing passwords

Prerequisites

- Existing connection between the configuration software and device

7.18.1 Assigning or changing passwords**Approach**

1. Establish connection to the device.
 2. In the device window under the main navigation **Service**, select the **User password** entry.
 3. In the **User password** dialog, select the user group.
 4. Enter the new password twice and use **Transmit to device** to confirm.
 5. When you are prompted to log on, select your user group and enter the corresponding password.
- ✓ The new password is valid for the user group immediately.

7.18.2 Resetting the password**Overview**

If you have forgotten the password of the Admin user group, you can reset it with the assistance of SICK.

Approach**Resetting the password**

1. Request the form for resetting your password from SICK support.
 2. Connect to the device in Safety Designer.
 3. In the device window under the main navigation **Service**, select the **User password** entry.
 4. In the **User password** dialog box, select the **Start password reset process** option.
 5. Send the information displayed on the form to SICK support.
 - ✓ You will then receive an activation code.
 6. Enter the activation code in the field provided.
 7. Read the PRAC (Password Reset Approval Code) from the device, enter it in the field provided, then confirm.
- ✓ The password of the **Admin** user group is reset to factory settings (SICKSAFE). The **Maintenance** and **Authorized customer** user groups are deactivated. The configuration

is not changed.

8 Commissioning

8.1 Switching on

Prerequisites

- The machine has been inspected and released by qualified safety personnel.
- Protective device works properly.
- The protection function is checked after each change to the machine or to the integration or the operating and boundary conditions of the device.

Switching on

When the camera sensor is switched on, the DIAG LED lights up yellow continuously.

When the startup process is complete, the LEDs indicate the current operational status of the camera sensor.

8.2 Check during commissioning and modifications

The thorough check is intended to ensure that the safety functions are fulfilling their planned purpose and whether persons are being adequately protected.

- ▶ Carry out the checks specified in the test plan of the manufacturer of the machine and the operating entity.

9 Operation

9.1 Status indicators

Overview

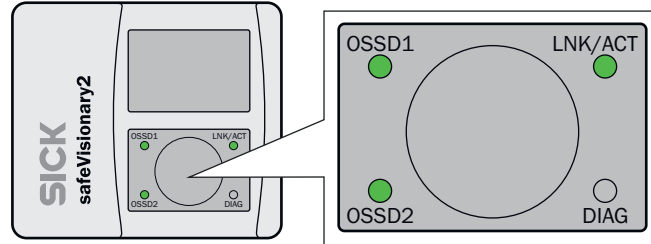

Figure 35: Status indicators

OSSD and DIAG status indicators

Table 39: OSSD and DIAG status indicators

LEDs			Status
OSSD1	OSSD2	DIAG	
● Green	● Green	○	<ul style="list-style-type: none"> All protective fields are clear All configured OSSDs are ON
● Red	● Red	○	<ul style="list-style-type: none"> All configured OSSDs are OFF No OSSDs configured
● Green	● Red	○	OSSD pair 1 is ON, OSSD pair 2 is OFF
● Red	● Green	○	OSSD pair 1 is OFF, OSSD pair 2 is ON
⦿ Red/ Yellow		○	Reset requested for OSSD pair 1
	⦿ Red/ Yellow	○	Reset requested for OSSD pair 2
● Green or red	● Green or red	● Yellow	Object detected in the warning field
		⦿ Green	The Identify function has been selected in the configuration software. The device flashes so it can be identified.
		⦿ / ●	The warning and error indications of the DIAG LED can be found under: " Fault indicators ", page 85

○ LED off. ⦿ LED flashes. ● LED illuminates. Empty cells mean that the LED lights up, flashes, or is off.

Ethernet status displays

Table 40: Ethernet status displays

LED LNK/ACT	Status
○	No Ethernet connection
● Green	EtherCAT connection present, no data transmission
⦿ Yellow	EtherCAT connection present, data is transmitted

○ LED off. ⦿ LED flashes. ● LED illuminates.

Further topics

- ["Status indicators", page 14](#)
- ["Fault indicators", page 85](#)

10 Maintenance

10.1 Cleaning the product

Overview

Depending on the ambient conditions, the front screen of the camera module and the front screen of the illumination unit must be cleaned regularly and in the event of contamination.

Important information



WARNING

Contamination or damage to the front screen of the camera module
If the optical properties of the camera module are impaired, persons or body parts might not be detected or not detected in time.

- ▶ Remove any contamination (e.g., droplets, condensation, frost, ice formation). Reboot device.
 - ▶ Keep the camera module free of substances containing oil and grease.
 - ▶ If the camera module is damaged, replace the device.
-



NOTICE

- ▶ Do not use aggressive or abrasive cleaning agents.
 - ▶ Recommendation: Use anti-static cleaning agents.
 - ▶ Recommendation: Use anti-static plastic cleaners and lens cloths from SICK.
-

Approach

1. Make sure that the dangerous state of the machine is and remains switched off during the cleaning.
2. Remove dust from the front screen of the camera module and the front screen of the illumination unit using a soft, clean brush.
3. Moisten a clean, soft towel with anti-static plastic cleaner. Wipe the front screens with it.
4. Check the effectiveness of the protective device.

Further topics

- ["Device overview", page 12](#)
- ["Accessories", page 102](#)

10.2 Regular thorough check

The thorough check is intended to ensure that the safety functions are fulfilling their planned purpose and whether persons are being adequately protected.

- ▶ Carry out the checks specified in the test plan of the manufacturer of the machine and the operating entity.

11 Troubleshooting

11.1 Fault indicators

Table 41: Fault indicators

LEDs	Error	Troubleshooting
DIAG		
● Red	Internal error	<ul style="list-style-type: none"> ▶ Restart the device via the Safety Designer or interrupt the voltage supply for at least 2 s. ▶ Replace the safety camera sensor and send it to the manufacturer for repair.
◐ Yellow	Temperature warning	▶ Mounting the heat sink
	Near range warning	▶ Check the near range
	Contamination warning ¹⁾	▶ Clean the front screens of the illumination unit and camera module
◐ Red	Contamination error	▶ Clean the front screens of the illumination unit and camera module
◐ Yellow/red	Configuration not verified	▶ Verifying configuration

○ LED off. ◐ LED flashes. ● LED illuminates.

¹⁾ There may be an object located in the warning field. A contamination warning overwrites the warning field status display.

Further topics

- ["Status indicators", page 14](#)
- ["Status indicators", page 82](#)
- ["Mounting the heat sink", page 50](#)
- ["Objects at close range", page 23](#)
- ["Cleaning the product", page 84](#)
- ["Verify configuration", page 77](#)

11.2 Diagnostics using Safety Designer

Diagnostic tools

The following diagnostics tools are available in the device window:

- **Data recorder**
- **Event history**
- **Message history**
- **Create diagnosis dump**

For information on the diagnostic dump, see the operating instructions for the Safety Designer item no. 8018178.

Interfaces

The following interfaces are suitable for diagnostics:

- Ethernet

11.2.1 Data recorder

Overview

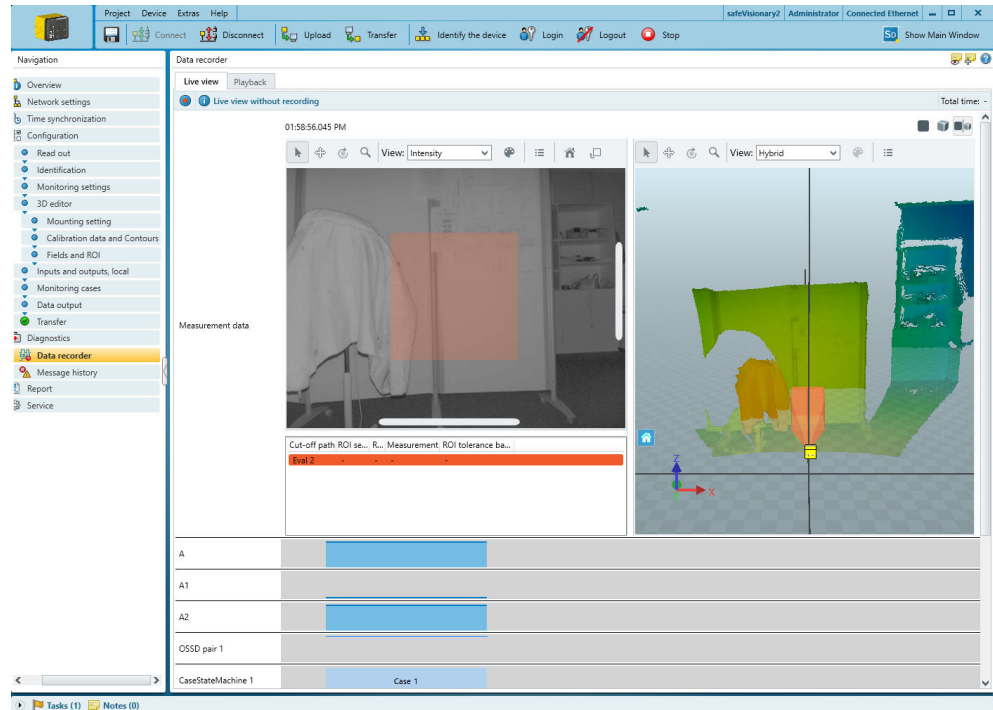

Figure 36: Data recorder

You can use the data recorder to record the device’s signals. Depending on the interface and the load on the interface, the measurement data may not be transmitted and shown for every detection cycle.

The data is saved in a data recorder diagnostics file.

You can play the data recorder diagnostic file in the data recorder.

You can adjust the settings in the Safety Designer main window.

Table 42: Data recorder

	Start recording
	Stop recording
	Full screen mode

Important information



NOTE

Recording with the data recorder can produce several gigabytes of data per minute.

- Ensure that sufficient storage space is available.

Prerequisites

- Existing connection between Safety Designer and device
- Configuration in the project and configuration in the device are synchronized.

Typical applications

- Check spatial geometry
- Check where a person can stay or when a person is detected
- Check input information about the current monitoring case
- Check why safety outputs have switched

11.2.2 Event history

Overview

The device stores data on important events. The event history displays information about the most recently stored events.

Event log

The device stores data on the following events:

- Safety output switches to the OFF state.
- Object detected in the protective field.
- Contour detection field: Deviations from the monitored contour detected.
- ROI measured value is outside the configured tolerance band.

For each event where a safety output switches to the OFF state, the device stores the data from 10 images.

When the internal memory of the device is full, the data of the oldest event is overwritten to store a new event. The position and time of the event are retained. The internal memory of the device is cleared during a restart and when transferring a configuration.

Data source

- **Read from device:** Only available when a device is connected. The data stored in the device will be read.
- **Clear event history:** Deletes all data from the event history.
- **Settings:** You can set here whether image data should be recorded. If you activate recording of image data, then depth data and intensity images are saved for each event. This additional data is not encrypted and can be viewed without authentication. Note the applicable data protection regulations.
- **Load file:** You can open a file that stores events that were previously read from a device.
- **Store data:** You can save the events read from a device to a file for later analysis.

Events

The **Events** view shows a graphical overview of the events that have led to a safety output switching to the OFF state.

In the navigation, you can select the event whose measurement data should be displayed.

The 2D view (left) shows the events of the ROIs.

The 3D view (right) shows the events of the fields.

If you click on an event, then that event is selected. The associated measurement data is displayed both in the 2D view (intensity data) and in the 3D view (depth data). Multiple sampling is displayed in the footer.

If multiple images are stored for the selected event, you can view the individual images one by one by clicking the icons next to **Scan**.

Event table

The event table shows detailed information about the events which have led to a safety output switching to the OFF state.

Based on the measurement data, a probable cause is assigned to each event:

- **Object:** Probably an object was detected in the protective field or in a ROI.
- **Contour:** A contour deviation was detected in the contour detection field.
- **Close to field edge:** An object was probably detected at the edge of the protective field.
- **Invalid measurement:** The detection zone is overexposed or underexposed. There are reflectors or dust in the detection zone. Insects, welding sparks or other particles have lead to an invalid measurement.
- **Obstruction:** Object detected in the close range of the camera.
- **Unknown:** Unknown event

Multiple sampling

The **Multiple sampling** view shows how often events with different durations occurred. You can select whether all events should be displayed or only individual events for specific cut-off paths, fields or ROIs.

In the **All** view, all detections in ROIs, protective fields and contour detection fields are taken into account. Therefore, the number of entries in this view may deviate from the other views.

The duration is specified as the number of successive images in which an event is detected. For each duration, the diagram shows the corresponding number of events.

Meta data

The **Meta data** view shows additional information.

You can add to a comment. When you save the event history, the comment is saved as well.

11.2.3 Message history

Type	Occurrence	End	Message	Acknowledged
Information	07-Dec-22 1:50:40 PM	-	Monitoring case switching	1
Information	07-Dec-22 1:50:38 PM	07-Dec-22 1:50:38 PM	Device started in test mode	
Information	07-Dec-22 1:50:38 PM	07-Dec-22 1:50:38 PM	Device started in test mode	
Information	07-Dec-22 1:49:41 PM	07-Dec-22 1:49:42 PM	Device started in test mode	
Information	07-Dec-22 1:49:41 PM	07-Dec-22 1:49:42 PM	Device started in test mode	
Warning	07-Dec-22 1:38:08 PM	-	E1 - Fault in the device	
Warning	07-Dec-22 1:38:08 PM	-	E1 - Fault in the device	
Error	07-Dec-22 1:38:08 PM	-	C1 - Faulty configuration	
Information	07-Dec-22 1:38:08 PM	07-Dec-22 1:49:42 PM	Device started in test mode	
Information	07-Dec-22 1:38:08 PM	07-Dec-22 1:49:42 PM	Device started in test mode	
Information	07-Dec-22 1:37:32 PM	-	Info Status of contamination	
Information	07-Dec-22 1:37:32 PM	-	Info Status of contamination	
Information	07-Dec-22 1:37:32 PM	-	Info Status of contamination	
Information	07-Dec-22 1:37:32 PM	-	Info Status of contamination	
Warning	07-Dec-22 1:37:25 PM	-	E1 - Fault in the device	
Warning	07-Dec-22 1:37:25 PM	-	E1 - Fault in the device	
Warning	07-Dec-22 1:37:24 PM	-	Warning laser current	
Warning	07-Dec-22 1:37:24 PM	-	Contamination warning	
Error	07-Dec-22 1:37:24 PM	-	C1 - Faulty configuration	

Code	0x43120000
Local time occurrence	1790/0 days 0 h 13 min 31 s 157 ms
Reason	Monitoring case switching from: 0 to: 1
Info 1	1
New monitoring case: 1	1
Previous monitoring case: 0	0
Info 4	0

Figure 37: Message history



- ① Message history
- ② Display filter
- ③ Details about the selected message

Events such as errors, warnings and information are stored in the message history.

By right-clicking on the table header, you can select the columns displayed in the message history.

Safety Designer shows details about the events in the bottom part of the window, ways to solve them are also shown.

Table 43: Print or export message history

	Print message history
	Save message history as a PDF
	Save message history as CSV

11.2.3.1 Fault indication

Overview

You will find detailed information on individual errors and information about events in the message history of the Safety Designer.

Fault indication

Table 44: Error types

Fault type	Brief description	Cause	Troubleshooting
C1	Faulty configuration	The configuration is faulty.	► Reconfigure the device.
C3	Incompatible firmware	The configuration does not match the device's firmware version.	► Check the firmware version of the device. ► Replace or reconfigure the device.
E1	Device error	The device has an internal error.	► Perform a device restart via the Safety Designer or interrupt the voltage supply for at least two seconds. ► Replace the device and send it to the manufacturer for repair.
E2			
F1	Current too high at an OSSD	The current is too high at an OSSD. The limit has been exceeded for current allowed short-term or permanently.	► Check connected switching element.
F2	OSSD short-circuit to 24 V	There is a short-circuit to 24 V at an OSSD.	► Check wiring.
F3	OSSD short circuit to 0 V	There is a short circuit to 0 V at an OSSD.	► Check wiring.
F4	Short-circuit between 2 OSSDs	There is a short-circuit between 2 OSSDs.	► Check wiring.
F5	Short-circuit between OSSD and universal input or universal I/O	There is a short-circuit between an OSSD and a universal input or between an OSSD and a universal I/O.	► Check wiring.
F9	General OSSD fault	At least one OSSD is showing unexpected behavior.	► Check the wiring of the OSSDs.
L2	Invalid configuration of the external device monitoring (EDM)	The configuration of the external device monitoring (EDM) is invalid. The configuration is unsuitable for the wiring.	► Check whether the external device monitoring is connected correctly. ► Check the configuration with Safety Designer.

Fault type	Brief description	Cause	Troubleshooting
L3	Fault in the external device monitoring (EDM)	A faulty signal is applied at the external device monitoring (EDM). The allowed tolerance time has been exceeded.	▶ Check whether the contactors are wired correctly and operating correctly.
L8	Fault in the reset input	An invalid signal is applied at a reset input. The reset signal is applied for too long.	▶ Check the reset pushbutton, the wiring, and any other components affected.
L9	Short-circuit at the reset input	Exactly the same signal is applied at a reset input as at another input, an OSSD or an output. There may be a short-circuit.	▶ Check wiring for cross-circuits.
M1	Incompatible configuration of the data output	The data output is configured in a way that the device does not support.	▶ Reconfigure the data output.
M2	Data output: Data packets lost	The data output could not transmit all data packets (for example, buffer memory full).	▶ Configure the data output so that less data is transmitted.
M3	Configuration not verified	The configuration is not verified.	▶ Verify the configuration.
N1	Invalid input signal	The signal applied at the control inputs is not assigned to a monitoring case. The signal is applied for longer than the set input delay +1 s.	▶ Check the configuration with Safety Designer. ▶ Check the working process of the machine.
N2	Incorrect switching sequence	The configured switching sequence was interrupted by the new monitoring case.	▶ Check the working process of the machine. ▶ Change configured switching order.
N3	Invalid input signal	The signal present at the static control inputs/parity inputs is invalid. The signal is applied for longer than 1 s.	▶ Check activation of the control inputs/parity inputs.
T1	Temperature error	The operating temperature of the device has exceeded or fallen below the permitted range.	▶ Check whether the device is being operated as per the permissible ambient conditions.
W1	Warnings exceed tolerance time	The combination of multiple warnings has resulted in a fault. The tolerance time of 1 s has been exceeded as there are multiple warnings.	▶ Use Safety Designer to check what warnings exist.

12 Decommissioning

12.1 Disposal

Approach

- ▶ Always dispose of unusable devices in accordance with national waste disposal regulations.



Complementary information

SICK will be glad to help you dispose of these devices on request.

13 Technical data

13.1 Data sheet

Features

Table 45: Features

Scanning range	see "Scanning range", page 97
Protective field range	≤ 2 m ≤ 4 m in Increased scanning range mode
Warning field range	≤ 7.3 m
ROI scanning range	≤ 4 m
Distance measurement range	≤ 16 m ¹⁾
Fields	≤ 24
Simultaneously monitored fields	≤ 3
Field sets	≤ 24
ROIs	≤ 40
Simultaneously monitored ROIs	≤ 5
ROI sets	≤ 40
Generally necessary protective field supplement (TZ = tolerance zone of the safety camera sensor)	65 mm
ROI measurement accuracy	± 50 mm

¹⁾ For values > 9 m, quality losses (e.g. larger statistical measurement errors) must be expected.

Safety-related parameters

Table 46: Safety-related parameters

Typ (IEC 61496)	Type 2
Safety integrity level (IEC 61508)	SIL 1
Safety integrity level (IEC 62061)	SIL 1
Category (ISO 13849)	Category 2
Performance level (ISO 13849)	PL c
PFH _D (mean probability of a dangerous failure per hour)	8×10^{-7}
T _M (mission time, ISO 13849)	20 years

Interfaces

Table 47: Interfaces

OSSD pairs	2 (configurable)
Voltage supply and I/O	
Connection type	Male connector, M12, 8-pin, A-coding (collective male connector for voltage supply and inputs and outputs)
Length of cable with 0.25 mm ² wire cross-section	10 m
Configuration and diagnostic interface	
Type of interface	Ethernet 1000Base-T, IEEE 802.3ab
Connection type	Female connector, M12, 8-pin, X-coded

Transmission rate	1,000 Mbit/s (GbE)
Length of cable	≤ 100 m
Requirements of the cable	Min. CAT5e

Electrical data

Table 48: Electrical data

Operating data	
Protection class (IEC 61140)	III
Supply voltage	24 V DC (16.8 V ... 30 V) (SELV/PELV)
Current consumption at 24 V	
Average current consumption with no output load	< 540 mA
In sleep mode with no output load	< 320 mA
Starting current / peak current	< 3.5 A
Average power consumption with no output load	< 13 W
Overvoltage category	II (IEC 61131-2)
Power-up delay	Typ. 30 s ¹⁾
Cable	For UL applications: Only use UL-listed cables that are rated for min. 80 °C.
Safety outputs (OSSD)	
Type of output	2 PNP semiconductors for each OSSD pair, short-circuit protected, cross-circuit monitored
Output voltage for ON state (HIGH)	(UV - 2 V) ... UV
Output voltage for OFF state (LOW)	0 V ... 2 V
Output current for ON state (HIGH)	0.5 mA ... 250 mA per OSSD pin Total output current for all outputs ≤ 500 mA
Leakage current	≤ 250 µA
Load inductance	≤ 2.2 H
Load capacity	≤ 1 µF in series with 50 Ω
Conductor resistance	≤ 4 Ω
Test pulse width	≤ 300 µs (typ. 230 µs)
Test pulse interval	Typ. 8 × detection cycle time
Duration of OFF state	≥ 80 ms
Discrepancy time (offset between switching from OSSD2 and OSSD1 within an OSSD pair)	≤ 10 ms
Universal output, universal I/O (configured as output)	
Output voltage HIGH	(UV - 2 V) ... UV ²⁾
Output voltage LOW	High impedance (1 MOhm pulldown)
Output current HIGH	0.5 mA ... 250 mA Total output current for all outputs ≤ 500 mA
Leakage current	≤ 250 µA
Switch-on delay	30 ms
Switch-off delay	30 ms
Static control input, universal input, universal I/O (configured as input)	
Input voltage HIGH	24 V (11 V ... 30 V)

Input voltage LOW	0 V (-30 V ... 5 V)
Input current HIGH	2 mA ... 3 mA
Input current LOW	0 mA ... 2 mA
Input capacitance	Typ. 10 nF
Input frequency (max. switching sequence when used as control input)	≤ 20 Hz
Sampling time	4 ms
Response time at EDM after switching on OSSDs (when used as EDM input)	300 ms
Actuating duration of control switch for reset (when used as reset input)	60 ms to 30 s
Actuating duration of switch for standby (when used as sleep mode input)	≥ 120 ms

- 1) The power-up delay may be different at ambient temperatures < 0 °C.
- 2) Voltages as measured directly at the device connection. The voltage drop across the cables must be considered separately.

Mechanical data

Table 49: Mechanical data

Dimensions (W × H × D)	70 mm × 80 mm × 77 mm
Weight	520 g
Housing material	Aluminum
Housing color	RAL 9005 (black) and RAL 1021 (colza yellow)
Material of the front screens	Polycarbonate

Ambient data

Table 50: Ambient data

Enclosure rating (IEC 60529)	IP65 and IP67
Ambient light immunity	3000 lux (IEC 61496-3), typical immunity 10 klx
Ambient operating temperature	-10 °C ... +50 °C At temperatures ≥ 40 °C, it is necessary to use heat sinks.
Storage temperature	-25 °C ... +70 °C
Air humidity	≤ 95%, non-condensing ¹⁾
Operating altitude	Max. 2,300 m above sea level
Vibration resistance	5 Hz ... 200 Hz / 1 g (IEC 60068-2-6)
Shock resistance, single shock	15 g, 11 ms (IEC 60068-2-27)
EMC	According to IEC 61496-1, IEC 61000-6-2, IEC 61000-6-4

- 1) IEC 61496-1, no. 4.3.1 and no. 5.4.2, IEC 61496-3, no. 4.3.1 and no. 5.4.2. Condensation has an influence on normal operation.

Miscellaneous data

Table 51: Miscellaneous data

Type of light	Pulsed laser
Wavelength	855 nm

Detectable remission	4% ... retroreflector (< 330 cd/Lux/sq.m) according to type 2, IEC 61496-3
Maximum uniform contamination of the front screens without reducing the detection capability	20%
Zone of limited detection capability	≤ 50 mm
Laser class	1 (IEC 60825-1)
Resolution of the depth data	512 px × 424 px
Field of view	68° × 42° (protective field evaluation) 68° × 58° (other field types and measurement data acquisition)
Image repeatability rate	30 Hz

1) In the event of heavy contamination, the device displays a contamination error and switches all safety outputs to the OFF state.

Table 52: Measurement uncertainty

	Remission 4% (typical)	Remission 100% (typical)		
		2 m	4 m	8 m
Scanning range	2 m	2 m	4 m	8 m
Statistical error (pixel) 1 σ	± 12 mm	± 2 mm	± 2 mm	± 5 mm
Systematic error	± 20 mm	± 20 mm	± 20 mm	± 40 mm

Example of statistical error: 68.2% of all measured values at 4% remission are within the limits of +/- 12 mm.

13.2 Response time

Overview

The protective device’s response time is the maximum time between the occurrence of the event leading to the sensor’s response and supply of the switch-off signal to the protective device’s interface (for example OFF state of the OSSD pair).

In addition to the protective device’s response time, further signal transmission and processing also influence the time up until the end of the dangerous state. This includes a control’s processing time and the response times of downstream contactors, for example.

Response time

Table 53: Response time

Multiple sampling	Response time in ms
1	55
2	89
3	123
4	157
5	191
6	225
7	259
8	293
9	327
10	361
11	395

Multiple sampling	Response time in ms
12	429
13	463
14	497
15	531
16	565

13.3 Course of the OSSD test over time

The safety camera sensor tests the OSSDs at regular intervals. To do this, the safety camera sensor switches each OSSD briefly to the OFF state and checks whether this channel is voltage-free during this time.

Make sure that the machine controller does not respond to these test pulses and the machine does not switch off.

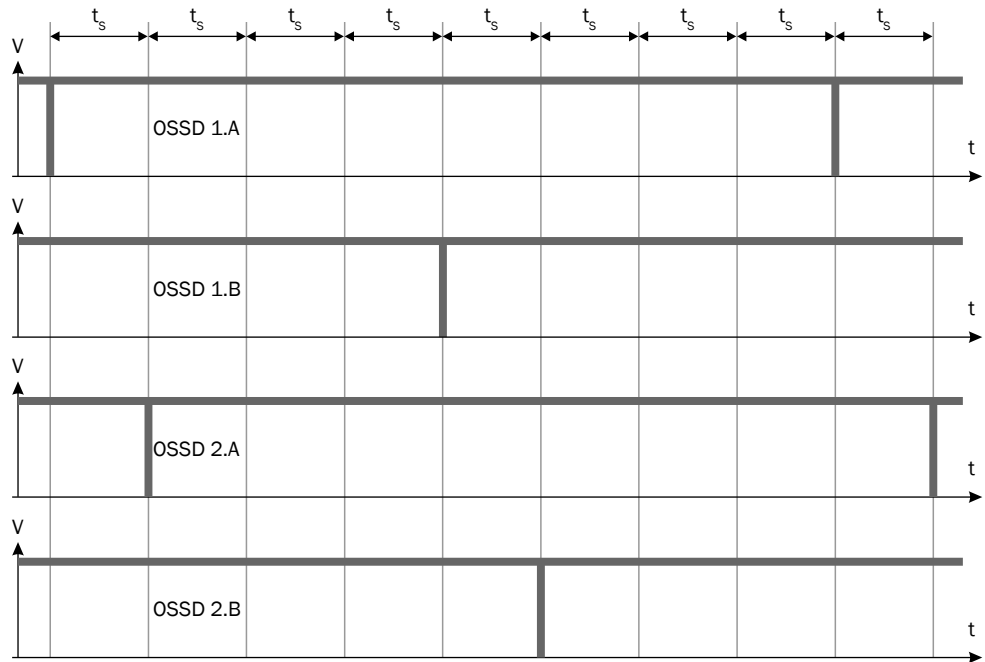

Figure 38: Switch-off tests

t_s Acquisition time $t_s = 30$ ms

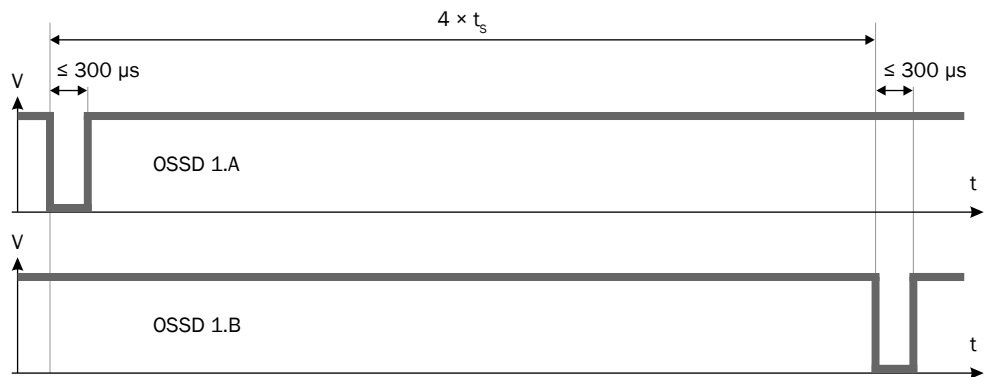

Figure 39: Duration and time offset for the switch-off tests in an OSSD pair

t_s Acquisition time $t_s = 30$ ms

13.4 Scanning range

Protective field range

The effective protective field range depends on the application and the configured object resolution.

Table 54: Protective field range

Resolution	Protective field range	
	Stationary application	Mobile application
Hand	1 m	1 m
Arm	1.6 m	1.6 m
Leg	2 m	2 m
Body	2 m 4 m in Increased scanning range mode	2 m 4 m in mode Increased scanning range ¹⁾

¹⁾ The increased scanning range in mobile applications can affect the availability of the device.

Scanning range of the contour detection field

The effective scanning range of the contour detection field depends on the application and the configured object resolution.

Table 55: Scanning range of the contour detection field

Resolution	Scanning range of the contour detection field	
	Stationary application	Mobile application
Hand	1 m	1 m
Arm	1.6 m	1.6 m
Leg	2 m	2 m
Body	2 m 4 m in Increased scanning range mode	2 m 4 m in mode Increased scanning range ¹⁾
1 m × 1 m (opening)	-	4 m
40 cm × 40 cm (opening)	-	2 m

¹⁾ The increased scanning range in mobile applications can affect the availability of the device.

Scanning range of the ROI measurement function

The scanning range of the ROI measurement function is limited to 4 m.

Warning field range

For non-safety applications, the safety camera sensor has a higher scanning range than the maximum protective field range. The scanning range is limited to 7.3 m for warning fields.

In order to reliably detect an object at 7.3 m, the object must be at least 174 mm in size and have a remission of at least 60%.

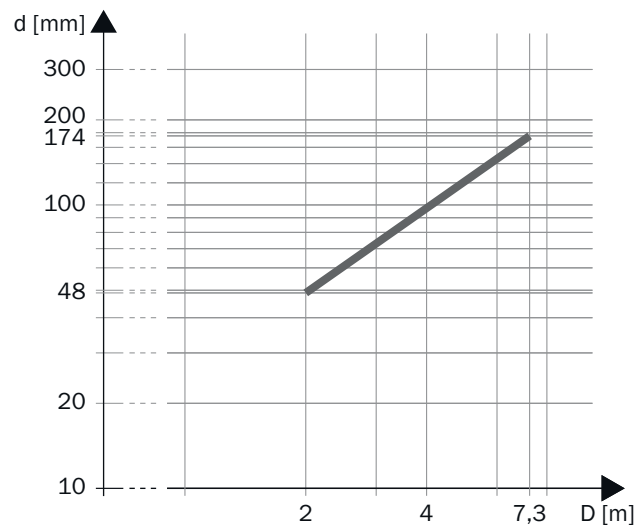

Figure 40: Scanning range and object size

d Required minimum size of the object in mm
D Scanning range in m

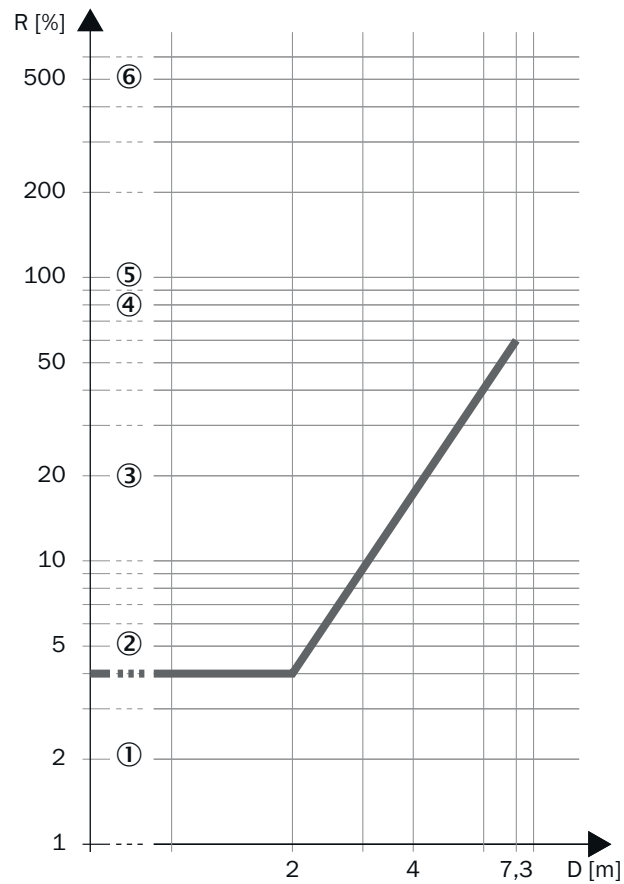

Figure 41: Scanning range and required reflectance

R Required minimum remission in %
D Scanning range in m
 ① Black shoe leather
 ② Matt black paint
 ③ Gray cardboard

- ④ Writing paper
- ⑤ White plaster
- ⑥ Reflectors > 2000%, reflective tapes > 300%

13.5 Dimensional drawings

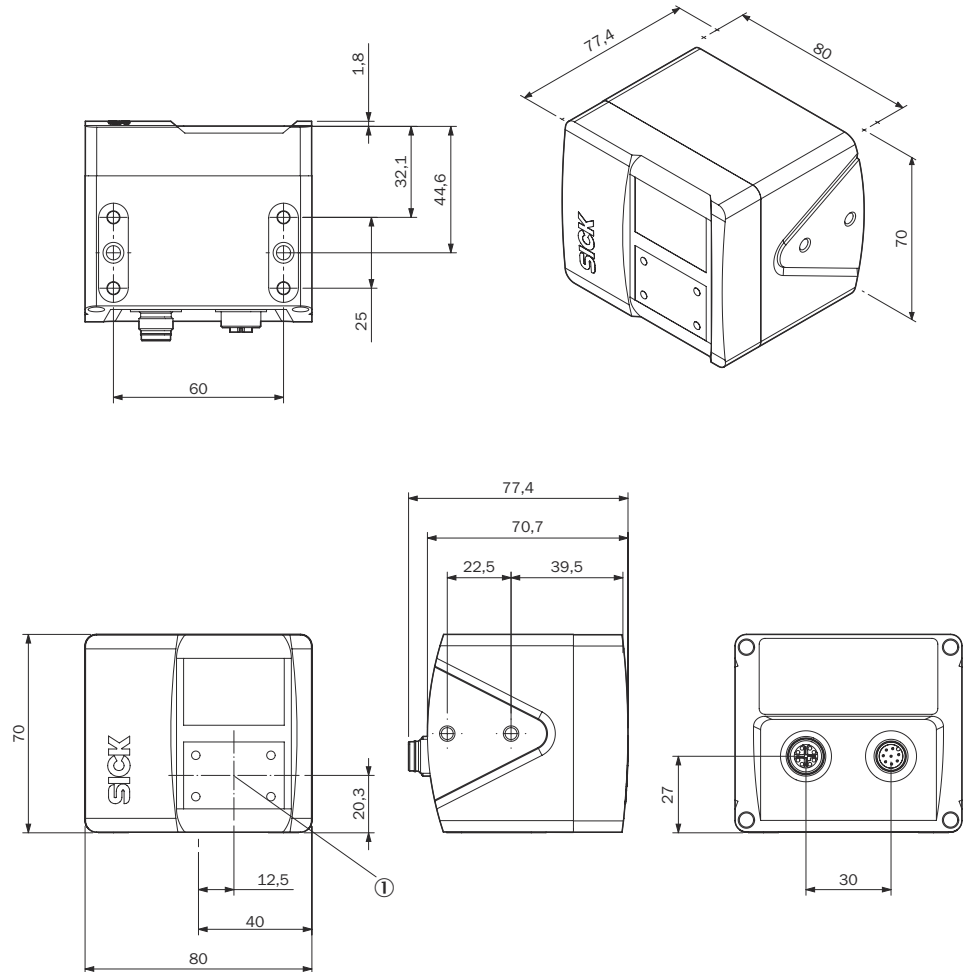

Figure 42: Dimensional drawing for the safety camera sensor

- ① Camera module

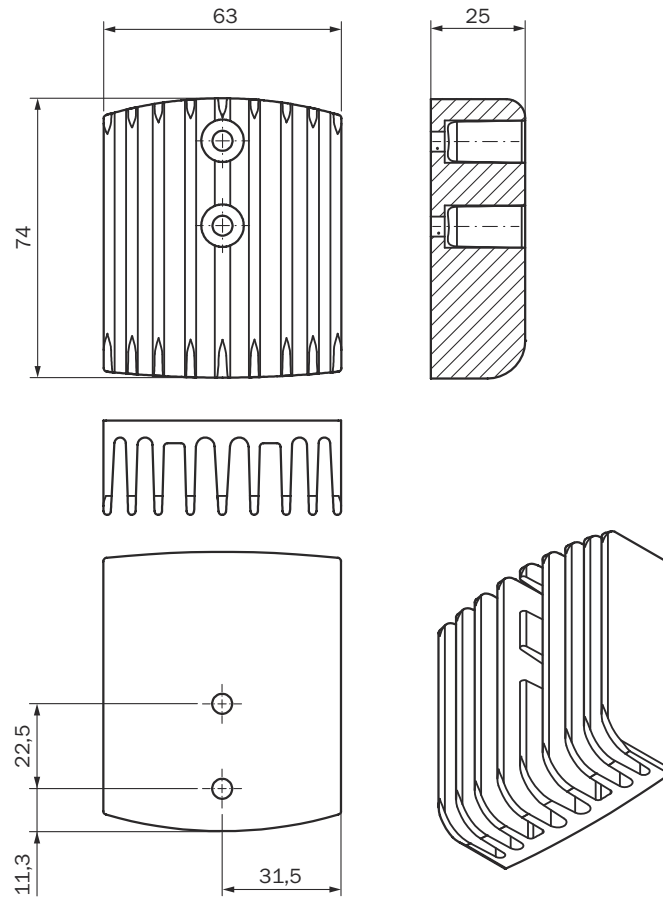

Figure 43: Dimensional drawing for the heat sink

14 Ordering information

14.1 Scope of delivery

- Safety camera sensor
- Safety note
- Mounting instructions
- Operating instructions for download: www.sick.com

14.2 Ordering information for the safety camera sensor

Table 56: Ordering information for the safety camera sensor

Part	Type code	Part number
safeVisionary2	V3SA2-ABBABBAAN1	1116398

15 Accessories

15.1 Accessories

Brackets

Table 57: Brackets ordering information

Part	Part number
Visionary mounting kit	2124497

Heat sink

Table 58: Ordering information for the heat sink

Part	Part number
Visionary heat sink	2127749

Cleaning agent

Table 59: Cleaning agent ordering information

Part	Part number
Anti-static plastic cleaner	5600006
Lens cloth	4003353

Additional accessories

16 Glossary

AGV	Automated guided vehicle
Contour detection field	The contour detection field monitors a contour of the environment. The electro-sensitive protective device switches the associated safety outputs to the OFF state if a contour does not correspond to the set specifications, e.g. because a door or flap is open.
Control input	<p>A control input receives signals, e.g. from the machine or from the control. Use of control inputs is how the protective device receives information about the conditions at the machine, e.g., if there is a change of operating mode. If the protective device is configured appropriately, it will activate a different monitoring case after receiving a new control input.</p> <p>The control input information must be transmitted reliably. Generally, at least 2 separate channels are used to do this.</p> <p>Depending on the device, a control input can be realized as a static control input or a dynamic control input.</p>
Dangerous state	<p>A dangerous state is a status of the machine or facility, where people may be injured. Protective devices prevent this risk if the machine is operated within its intended use.</p> <p>The figures in this document always show the dangerous state of the machine as movement of a machine part. In practice, there are different dangerous states, such as:</p> <ul style="list-style-type: none"> • Machine movements • Electrical parts • Visible and invisible beam • A combination of multiple hazards
EDM	External device monitoring
Electro-sensitive protective device	<p>An electro-sensitive protective device is a device or system of devices for safety-related detection of people or parts of the body.</p> <p>It is used to protect people from machines and facilities that pose a risk of injury. It triggers the machine or facility to adopt a safe state before a person is exposed to a hazardous situation.</p> <p>Examples: Safety light curtain, safety laser scanner.</p>
ESPE	Electro-sensitive protective device
EtherCAT	<p>EtherCAT® (Ethernet for Control Automation Technology) is an Ethernet-based network used in industrial automation.</p> <p>With the Safety over EtherCAT® (FSoE, FailSafe over EtherCAT) protocol extension, EtherCAT® is also suitable for safety-related data communication.</p>
External device monitoring	<p>The external device monitoring (EDM) monitors the status of downstream contactors.</p> <p>In order to use external device monitoring, positively guided contactors must be used to switch off the machine. If the auxiliary contacts of the positively guided contactors are connected to the external device monitoring, the external device monitoring checks whether the contactors switch correctly when the OSSDs are switched off.</p>
Field set	<p>A field set consists of one or more fields. The fields in a field set are monitored simultaneously.</p> <p>A field set can contain different field types, e.g., a protective field and a warning field.</p>

Hazardous area	Hazardous area is any space within and/or around machinery in which a person can be exposed to a hazard. (ISO 12100)
Monitoring case	<p>A monitoring case indicates the machine status to the sensor. Generally, one field set is assigned to each monitoring case.</p> <p>The sensor receives a defined signal for the current machine status. When a signal change occurs, the sensor activates the monitoring case and thereby the field set that is associated with the new machine status.</p>
OFF state	The OFF state is the status of the outputs of the protective device, where the controlled machine is triggered to quit its dangerous state and the start-up of the machine is prevented (e.g., the voltage at the OSSDs is LOW, so that the machine is switched off and remains still).
ON state	The ON state is the status of the outputs of the ESPE, where the controlled machine is permitted to operate (e.g., the voltage at the OSSDs is HIGH so that the machine can run).
OSSD	<p>Output signal switching device: signal output for the protective device, which is used for stopping the dangerous movement.</p> <p>An OSSD is a safety switching output. The functionality of each OSSD is tested periodically. OSSDs are always connected in pairs and must undergo dual-channel analysis for safety reasons. An OSSD pair is formed from 2 OSSDs that are connected and analyzed together.</p>
PFH_D	Probability of dangerous failure per hour
PL	Performance level (ISO 13849)
Protective field	The protective field is the area in which the test object specified by the manufacturer is detected by the electro-sensitive protective equipment (ESPE). As soon as the electro-sensitive protective device detects an object in the protective field, it switches the associated safety outputs to the OFF state. This signal can be passed to controllers resulting in the dangerous state coming to an end, e.g. to stop the machine or the vehicle.
Reset	<p>When a protective device has sent a stop command, the stopped state must be maintained until a reset device is activated and the machine can be restarted in a second step.</p> <p>The reset brings the protective device back to the monitoring state after it has sent a stop command. The reset also quits the start-up or restart interlock of a protective device, so that the machine can be restarted in a second step.</p> <p>The reset must only be possible, when all safety functions and protective devices are functional.</p> <p>The reset of the protective device must not introduce any movement or dangerous situations itself. The machine is only permitted to start after the reset once a separate start command has been sent.</p> <ul style="list-style-type: none"> • Manual resets are performed using a separate, manually operated device, such as a reset pushbutton. • Automatic resets by the protective device are only permitted in special cases, if one of the following conditions is met: <ul style="list-style-type: none"> ○ It must not be possible for people to be in the hazardous area without triggering the protective device. ○ It must be ensured that no people are in the hazardous area during or after the reset.
Resolution	The resolution of an active opto-electronic protective device (also known as the sensor detection capability) is the minimum size of an object for it to be reliably detected.

Response time	The protective device's response time is the maximum time between the occurrence of the event leading to the sensor's response and supply of the switch-off signal to the protective device's interface (for example OFF state of the OSSD pair).
Restart interlock	<p>The restart interlock prevents the machine from automatically starting up, for example after a protective device has responded while the machine is operating or after changing the machine's operating mode.</p> <p>The restart interlock can be implemented in the protective device or in the safety controller.</p> <p>A command to reset the protective device must be given, for example using a reset pushbutton, before the machine can be restarted.</p>
Retroreflector	A retroreflector reflects light back toward the light source largely independently of the alignment of the retroreflector.
ROI	Region of interest: Selected range of measured values that can be used, for example, for further analysis.
ROI set	An ROI set consists of one or more ROIs.
Safety function	Function of a machine whose failure can result in an immediate increase of the risk(s). (ISO 12100)
Safety output	<p>A safety output provides safety-related information.</p> <p>Safety outputs are OSSDs, for example, or safety-related information on a safety-related network.</p>
SIL	Safety integrity level
Static control input	A static control input is a dual-channel control input, which evaluates the status of every channel as the value 0 or 1. The signal states of one or more static control inputs give a unique signal pattern. This signal pattern activates a monitoring case.
Universal I/O	Universal I/O can be configured as universal input or as universal output.
Universal input	Depending on the device, a universal input can be used for resetting, external device monitoring (EDM), sleep mode, or restarting the protective device, for example. If sleep mode is activated by a universal input, the sleep mode must not be used for safety applications. Certain universal inputs can also be used in pairs as a static control input.
Universal output	The function of a universal output is configurable. Which functions are available depends on the device. Possible signals are, for example: reset required, contamination warning.
Warning field	<p>The warning field monitors larger areas than the protective field. Simple switching functions can be triggered with the warning field, e.g. a warning light or an acoustic signal can be triggered if a person approaches, even before the person enters the protective field.</p> <p>The warning field must not be used for safety applications.</p>

17 Annex

17.1 Conformities and certificates

You can obtain declarations of conformity, certificates, and the current operating instructions for the product at www.sick.com. To do so, enter the product part number in the search field (part number: see the entry in the “P/N” or “Ident. no.” field on the type label).

17.1.1 EU declaration of conformity

Excerpt

The undersigned, representing the manufacturer, herewith declares that the product is in conformity with the provisions of the following EU directive(s) (including all applicable amendments), and that the standards and/or technical specifications stated in the EU declaration of conformity have been used as a basis for this.

- ROHS DIRECTIVE 2011/65/EU
- EMC DIRECTIVE 2014/30/EU
- MACHINERY DIRECTIVE 2006/42/EC

17.2 Note on standards

Standards are specified in the information provided by SICK. The table shows regional standards with similar or identical contents. Not every standard applies to all products.

Table 60: Note on standards

Standard	Standard (regional)
	China
IEC 60068-2-6	GB/T 2423.10
IEC 60068-2-27	GB/T 2423.5
IEC 60204-1	GB/T 5226.1
IEC 60529	GB/T 4208
IEC 60825-1	GB 7247.1
IEC 61131-2	GB/T 15969.2
IEC 61140	GB/T 17045
IEC 61496-1	GB/T 19436.1
IEC 61496-2	GB/T 19436.2
IEC 61496-3	GB 19436.3
IEC 61508	GB/T 20438
IEC 62061	GB 28526
ISO 13849-1	GB/T 16855.1
ISO 13855	GB/T 19876

17.3 Licenses

SICK uses open source software which is published by the rights holders under a free license. Among others, the following license types are used: GNU General Public License (GPL version 2, GPL version 3), GNU Lesser General Public License (LGPL), MIT license, zlib license and licenses derived from the BSD license.

This program is provided for general use without warranty of any kind. This warranty disclaimer also extends to the implicit assurance of marketability or suitability of the program for a particular purpose.

See the GNU General Public License for more information. For complete license texts, see www.sick.com/licensetexts. Printed copies of the license texts are also available on request.

17.4 Checklist for initial commissioning and commissioning

Checklist for manufacturers or installers for installing electro-sensitive protective device (ESPE)

The details relating to the items listed below must be available no later than when the system is commissioned for the first time. However, these depend on the specific application (the requirements of which must be reviewed by the manufacturer or installer).

This checklist should be retained and kept with the machine documentation to serve as reference during recurring tests.

This checklist does not replace the initial commissioning, nor the regular inspection by qualified safety personnel.

Have the safety rules and regulations been observed in compliance with the directives and standards applicable to the machine?	Yes <input type="checkbox"/> No <input type="checkbox"/>
Are the applied directives and standards listed in the declaration of conformity?	Yes <input type="checkbox"/> No <input type="checkbox"/>
Does the protective device correspond to the required PL/SIL and PFHd in accordance with ISO 13849-1 / IEC 62061 and the required type in accordance with IEC 61496-1?	Yes <input type="checkbox"/> No <input type="checkbox"/>
Is access to the hazardous area or hazardous point only possible through the protective field of the ESPE?	Yes <input type="checkbox"/> No <input type="checkbox"/>
Have appropriate measures been taken to protect (mechanical protection) or monitor (protective devices) any persons or objects in the hazardous area when protecting a hazardous area or hazardous point, and have these devices been secured or locked to prevent their removal?	Yes <input type="checkbox"/> No <input type="checkbox"/>
Are additional mechanical protective measures fitted and secured against manipulation which prevent reaching below, above or around the ESPE?	Yes <input type="checkbox"/> No <input type="checkbox"/>
Has the maximum shutdown and/or stopping time of the machine been measured, specified and documented (at the machine and/or in the machine documentation)?	Yes <input type="checkbox"/> No <input type="checkbox"/>
Has the ESPE been mounted such that the required minimum distance from the nearest hazardous point has been achieved?	Yes <input type="checkbox"/> No <input type="checkbox"/>
Are the ESPE devices properly mounted and secured against manipulation after alignment?	Yes <input type="checkbox"/> No <input type="checkbox"/>
Are the required protective measures against electric shock in effect (protection class)?	Yes <input type="checkbox"/> No <input type="checkbox"/>
Is the control switch for resetting the protective devices (ESPE) or restarting the machine present and correctly installed?	Yes <input type="checkbox"/> No <input type="checkbox"/>
Are the outputs of the ESPE (OSSDs or safety outputs via the network) integrated according to the required PL/SIL in accordance with ISO 13849-1 / IEC 62061 and does the integration correspond to the circuit diagrams?	Yes <input type="checkbox"/> No <input type="checkbox"/>
Has the protective function been checked in compliance with the test notes of this documentation?	Yes <input type="checkbox"/> No <input type="checkbox"/>
Are the specified protective functions effective at every operating mode that can be set?	Yes <input type="checkbox"/> No <input type="checkbox"/>
Are the switching elements activated by the ESPE, e.g. contactors, valves, monitored?	Yes <input type="checkbox"/> No <input type="checkbox"/>
Is the ESPE effective over the entire period of the dangerous state?	Yes <input type="checkbox"/> No <input type="checkbox"/>
Once initiated, will a dangerous state be stopped when switching the ESPE on or off and when changing the operating mode, or when switching to another protective device?	Yes <input type="checkbox"/> No <input type="checkbox"/>

18 List of figures

1.	Laser class 1.....	9
2.	Device overview.....	12
3.	Size of the detection zone.....	13
4.	Status indicators.....	14
5.	Origin of the device coordinate system.....	15
6.	Device coordinate system in the world coordinate system.....	15
7.	Example of hazardous area protection.....	18
8.	Example of mobile hazardous area protection - personal protection.....	19
9.	Collision protection example.....	19
10.	Example of access protection.....	20
11.	Fall protection example.....	20
12.	ROI example.....	21
13.	Example of a non-detected area between the vehicle and protective field.....	23
14.	Prevent crawling beneath.....	24
15.	Prevent reaching over.....	25
16.	Distance of the protective field from the wall.....	25
17.	Orthogonal approach to the optical axis, example 1.....	27
18.	Orthogonal approach to the optical axis, example 2.....	27
19.	Parallel approach to the optical axis.....	28
20.	Hazardous area protection.....	29
21.	Access protection.....	32
22.	Mobile hazardous area protection.....	34
23.	Stopping distance as a function of the vehicle's speed.....	36
24.	Fall protection.....	37
25.	Dual-channel and isolated connection of an OSSD pair.....	40
26.	No potential difference between load and protective device.....	40
27.	Mounting the heat sink.....	50
28.	Male connector M12, 8-pin, A-coded.....	52
29.	Female connector, M12, 8-pin, X-coded.....	53
30.	Software controls.....	55
31.	3D editor.....	62
32.	Inputs and outputs, local.....	70
33.	Monitoring cases.....	73
34.	Report.....	78
35.	Status indicators.....	82
36.	Data recorder.....	86
37.	Message history.....	88
38.	Switch-off tests.....	96
39.	Duration and time offset for the switch-off tests in an OSSD pair.....	96
40.	Scanning range and object size.....	98
41.	Scanning range and required reflectance.....	98
42.	Dimensional drawing for the safety camera sensor.....	99
43.	Dimensional drawing for the heat sink.....	100

19 List of tables

1.	Target groups and selected sections of these operating instructions.....	7
2.	Size of the detection zone.....	13
3.	Status indicators.....	14
4.	Protective field.....	16
5.	Contour detection field.....	16
6.	Region of interest (ROI).....	17
7.	Warning field.....	17
8.	Supplement C with orthogonal approach to the optical axis, hazardous area protection.....	30
9.	Supplement C with parallel approach to the optical axis, hazardous area protection.....	30
10.	Supplement C for approach orthogonal to the optical axis, hazardous point protection.....	31
11.	Safety supplement C with parallel approach to the optical axis, hazardous point protection.....	32
12.	Supplement C with orthogonal approach to the optical axis, access protection...	33
13.	Supplement C with parallel approach to the optical axis, access protection.....	33
14.	Supplement C, mobile hazardous area protection.....	35
15.	Status of the channels of the control inputs with complementary evaluation.....	41
16.	True vales with 1-off-n-evaluation with 2 input pairs (example).....	41
17.	State of the channels of the control inputs for a parity check using 3 channels...	42
18.	State of the channels of the control inputs for a parity check using 4 channels...	42
19.	Network services and ports.....	44
20.	Test object.....	45
21.	Pin assignment M12, 8-pin.....	52
22.	Pin assignment.....	53
23.	User groups.....	56
24.	Checksums of the safety camera sensor.....	58
25.	Recommended object resolution.....	60
26.	Recommended multiple sampling.....	61
27.	Buttons on the toolbar.....	63
28.	Buttons on the toolbar.....	63
29.	Buttons on the calibration data toolbar.....	65
30.	Buttons on the Fields toolbar.....	66
31.	Properties of the fields and field sets.....	66
32.	Minimum cuboid size.....	67
33.	Mask areas.....	68
34.	Defining global field geometry.....	68
35.	Buttons on the ROI toolbar.....	69
36.	Properties of the ROIs and ROI sets.....	69
37.	Empirical values for the required input delay.....	74
38.	Show/Hide permanent presets.....	75
39.	OSSD and DIAG status indicators.....	82
40.	Ethernet status displays.....	82
41.	Fault indicators.....	85
42.	Data recorder.....	86
43.	Print or export message history.....	89
44.	Error types.....	89
45.	Features.....	92
46.	Safety-related parameters.....	92
47.	Interfaces.....	92
48.	Electrical data.....	93
49.	Mechanical data.....	94
50.	Ambient data.....	94

51. Miscellaneous data.....	94
52. Measurement uncertainty.....	95
53. Response time.....	95
54. Protective field range.....	97
55. Scanning range of the contour detection field.....	97
56. Ordering information for the safety camera sensor.....	101
57. Brackets ordering information.....	102
58. Ordering information for the heat sink.....	102
59. Cleaning agent ordering information.....	102
60. Note on standards.....	106

Australia

Phone +61 (3) 9457 0600
1800 33 48 02 – tollfree
E-Mail sales@sick.com.au

Austria

Phone +43 (0) 2236 62288-0
E-Mail office@sick.at

Belgium/Luxembourg

Phone +32 (0) 2 466 55 66
E-Mail info@sick.be

Brazil

Phone +55 11 3215-4900
E-Mail comercial@sick.com.br

Canada

Phone +1 905.771.1444
E-Mail cs.canada@sick.com

Czech Republic

Phone +420 234 719 500
E-Mail sick@sick.cz

Chile

Phone +56 (2) 2274 7430
E-Mail chile@sick.com

China

Phone +86 20 2882 3600
E-Mail info.china@sick.net.cn

Denmark

Phone +45 45 82 64 00
E-Mail sick@sick.dk

Finland

Phone +358-9-25 15 800
E-Mail sick@sick.fi

France

Phone +33 1 64 62 35 00
E-Mail info@sick.fr

Germany

Phone +49 (0) 2 11 53 010
E-Mail info@sick.de

Greece

Phone +30 210 6825100
E-Mail office@sick.com.gr

Hong Kong

Phone +852 2153 6300
E-Mail ghk@sick.com.hk

Hungary

Phone +36 1 371 2680
E-Mail ertebsites@sick.hu

India

Phone +91-22-6119 8900
E-Mail info@sick-india.com

Israel

Phone +972 97110 11
E-Mail info@sick-sensors.com

Italy

Phone +39 02 27 43 41
E-Mail info@sick.it

Japan

Phone +81 3 5309 2112
E-Mail support@sick.jp

Malaysia

Phone +603-8080 7425
E-Mail enquiry.my@sick.com

Mexico

Phone +52 (472) 748 9451
E-Mail mexico@sick.com

Netherlands

Phone +31 (0) 30 204 40 00
E-Mail info@sick.nl

New Zealand

Phone +64 9 415 0459
0800 222 278 – tollfree
E-Mail sales@sick.co.nz

Norway

Phone +47 67 81 50 00
E-Mail sick@sick.no

Poland

Phone +48 22 539 41 00
E-Mail info@sick.pl

Romania

Phone +40 356-17 11 20
E-Mail office@sick.ro

Singapore

Phone +65 6744 3732
E-Mail sales.gsg@sick.com

Slovakia

Phone +421 482 901 201
E-Mail mail@sick-sk.sk

Slovenia

Phone +386 591 78849
E-Mail office@sick.si

South Africa

Phone +27 10 060 0550
E-Mail info@sickautomation.co.za

South Korea

Phone +82 2 786 6321/4
E-Mail infokorea@sick.com

Spain

Phone +34 93 480 31 00
E-Mail info@sick.es

Sweden

Phone +46 10 110 10 00
E-Mail info@sick.se

Switzerland

Phone +41 41 619 29 39
E-Mail contact@sick.ch

Taiwan

Phone +886-2-2375-6288
E-Mail sales@sick.com.tw

Thailand

Phone +66 2 645 0009
E-Mail marcom.th@sick.com

Turkey

Phone +90 (216) 528 50 00
E-Mail info@sick.com.tr

United Arab Emirates

Phone +971 (0) 4 88 65 878
E-Mail contact@sick.ae

United Kingdom

Phone +44 (0)17278 31121
E-Mail info@sick.co.uk

USA

Phone +1 800.325.7425
E-Mail info@sick.com

Vietnam

Phone +65 6744 3732
E-Mail sales.gsg@sick.com

Detailed addresses and further locations at www.sick.com

