

- > Ø 20 ... 63 mm
 - > Conforms to ISO 21287
 - > M/50 switches can be mounted flush with the profile
 - > Magnetic piston as standard
- > Seals ensure low friction operation and long life

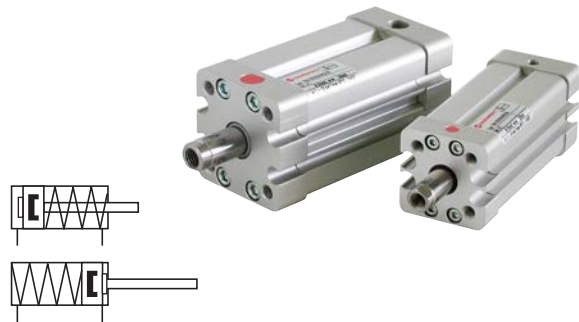

Technical features

Medium:

Compressed air, filtered, lubricated or non-lubricated

Standard:

Based on ISO 21287

Note: The basic length of the single acting version is slightly longer than its double acting equivalent

Operation:

RA/191000/M: Single acting, sprung in, magnetic piston, male piston rod thread, buffer cushioning

RA/191000/MX: Single acting, sprung in, magnetic piston, female piston rod thread, buffer cushioning

RA/193000/M: Single acting, sprung out, magnetic piston, male piston rod thread, buffer cushioning

RA/193000/MX: Single acting, sprung out, magnetic piston, female piston rod thread, buffer cushioning

Operating pressure:

2 ... 10 bar (29 ... 145 psi)

Port size:

M5, G1/8

Cylinder diameters:

20, 25, 32, 40, 50 and 63

Standard strokes:

Standard: 5, 10 and 25 mm

Non-standard strokes available (50 mm max.)

Operating temperature:

-5 ... +80°C max. (+23 ... +176°F)

Air supply must be dry enough to avoid ice formation at temperatures below +2°C (+35°F).

Materials:

Materials:

Profile barrel:

Anodized aluminium

End covers: Pressure diecast aluminium

Piston rod: Stainless steel

Piston rod seals: PUR

Piston seals: NBR

O-rings: NBR



Technical data

Cylinder Ø (mm)	20	25	32	40	50	63
Port size	M 5	M 5	G 1/8	G 1/8	G 1/8	G 1/8
Piston rod Ø (mm)	10	10	12	16	20	20
Piston rod thread	M8x1,25	M8x1,25	M10x1,25	M10x1,25	M12x1,25	M12x1,25
Energy (J) max.	0,20	0,30	0,45	0,75	1,10	1,30
RA/1910**/*						
Theoretical thrusts at 6 bar outstroke (N)	161	264	432	687	1043	1770
Theoretical thrusts F1 instroke (N)	14,5	20	32	44	56,5	74,5
Air consumption at 6 bar outstroke (l/cm)	0,022	0,035	0,056	0,088	0,138	0,218
RA/1930**/*						
Theoretical thrusts at 6 bar instroke (N)	119	197	311	566	906	1582
Theoretical thrusts at F1 bar outstroke (N)	14,5	20	32	44	56,5	74,5
Air consumption at 6 bar instroke (l/cm)	0,017	0,027	0,042	0,074	0,116	0,196

Standard strokes

Cylinder Ø (mm)	Stroke length (mm)		
	5	10	25
20	•	•	—
25	•	•	—
32	—	•	•
40	—	•	•
50	—	•	•
63	—	•	•

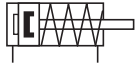
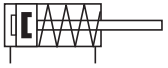
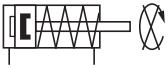
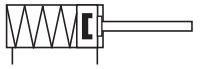
Cylinder variants

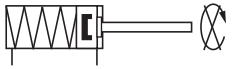
Symbol	S	Model with magnetic piston	Description	Dimensions Page
	•	RA/191000/M	Standard cylinder, male piston rod thread	5
	•	RA/191000/MX	Standard cylinder, female piston rod thread	5
	•	RA/191000/MU	Cylinder with extended piston rod, male piston rod thread	5
	•	RA/191000/MUX	Cylinder with extended piston rod, female piston rod thread	5
		RA/191000/N2	Cylinder with non-rotating piston rod, male piston rod thread	6
		RA/191000/N2X	Cylinder with non-rotating piston rod, female piston rod thread	6
	•	RA/193000/M	Standard cylinder, male piston rod thread	5
	•	RA/193000/MX	Standard cylinder, female piston rod thread	5
	•	RA/193000/MU	Cylinder with extended piston rod, male piston rod thread	5
	•	RA/193000/MUX	Cylinder with extended piston rod, female piston rod thread	5
		RA/193000/N2	Cylinder with non-rotating piston rod, male piston rod thread	6
		RA/193000/N2X	Cylinder with non-rotating piston rod, female piston rod thread	6

For cylinder variants S see options selector

Option selector



Note: If option is not required, disregard option position within part number eg. RA/191032/M/25. For combinations of cylinder variants consult our technical service.

This options selector explains only the cylinder variants.

Additional variants/options can not be derived from.



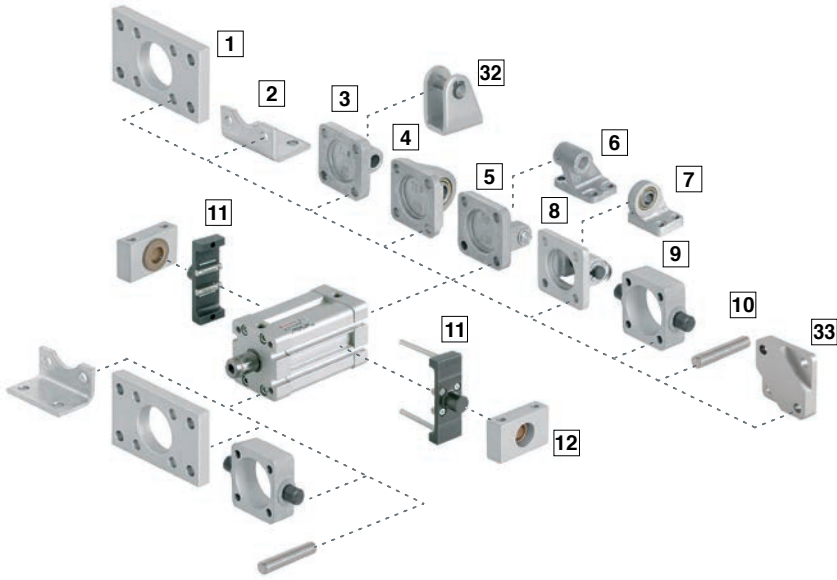

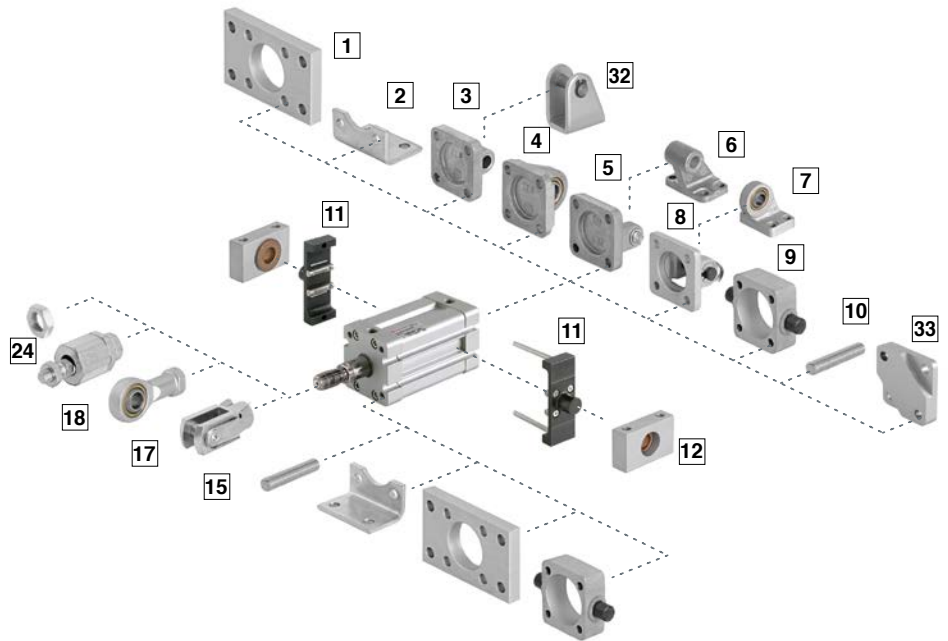

Series RA/191000/MX









Series RA/191000/M



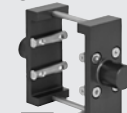





Mountings

Model	A	B, G	C	D	D2	FH	L2
							
	10	1	2	5	8	9	32
Ø	Page 7	Page 7	Page 7	Page 7	Page 7	Page 8	Page 9
20	—	QA/192020/22	QM/192020/21	—	—	—	QM/8020/44
25	—	QA/192025/22	QM/192025/21	—	—	—	QM/8020/44
32	QM/8032/35	QA/8032/22	QA/192032/21	QA/8032/23	QA/8032/42	QA/8032/34	—
40	QM/8032/35	QA/8040/22	QA/192040/21	QA/8040/23	QA/8040/42	QA/8040/34	—
50	QM/8050/35	QA/8050/22	QA/192050/21	QA/8050/23	QA/8050/42	QA/8050/34	—
63	QM/8050/35	QA/8063/22	QA/192063/21	QA/8063/23	QA/8063/42	QA/8063/34	—

Model	R	S	SW	UH	UR	US	Assembly Kit
							
	3	12	6	11	4	7	33
Ø	Page 8	Page 9	Page 9	Page 8	Page 8	Page 10	Page 10
20	QM/192020/27	—	—	—	—	—	QA/192020/55
25	QM/192025/27	—	—	—	—	—	QA/192025/55
32	QA/8032/27	QA/8032/41	M/P19493	PQA/182032/40	QA/8032/33	M/P40310	QA/192032/55
40	QA/8040/27	QA/8040/41	M/P19494	PQA/182040/40	QA/8040/33	M/P40311	QA/192040/55
50	QA/8050/27	QA/8040/41	M/P19495	PQA/182050/40	QA/8050/33	M/P40312	QA/192050/55
63	QA/8063/27	QA/8063/41	M/P19496	PQA/182063/40	QA/8063/33	M/P40313	QA/192063/55

For cylinders with male piston rod thread

Accessories

Model	AK	F	N2	UF	Groove cover	Magnetically operated switches	Groove key
							
	18	15	24	17			
Ø	Page 7	Page 8	Page 9	Page 8	Page 10	Page 11 & 12	Page 10
20	QM/8020/38	QM/8020/25	M/P1501/60	QM/8020/32	M/P72725/1000		M/P72816
25	QM/8020/38	QM/8020/25	M/P1501/60	QM/8020/32	M/P72725/1000		M/P72816
32	QM/8025/38	QM/8025/25	M/P1501/89	QM/8025/32	M/P72725/1000		M/P72816
40	QM/8025/38	QM/8025/25	M/P1501/89	QM/8025/32	M/P72725/1000		M/P72816
50	QM/8040/38	QM/8040/25	M/P1501/90	QM/8040/32	M/P72725/1000		M/P72816
63	QM/8040/38	QM/8040/25	M/P1501/90	QM/8040/32	M/P72725/1000		M/P72816

Service kit

Service kit

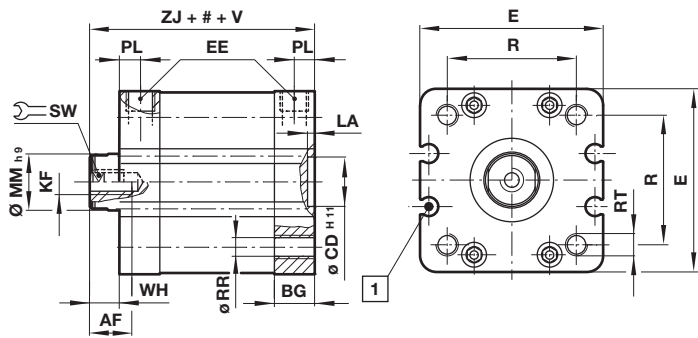

Ø	Ø	Model
20	40	QM/192040/00
25	50	QM/192050/00
32	63	QM/192063/00

Dimensions
**RA/191000/MX – Standard cylinders
Sprung in with female piston rod thread**

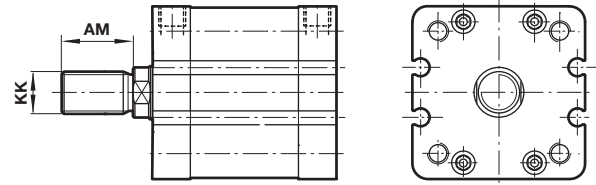
**RA/191000/M – Standard cylinders
Sprung in with male piston rod thread**

 Dimensions in mm
Projection/First angle

Stroke

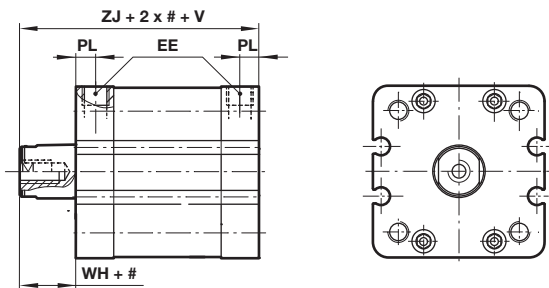
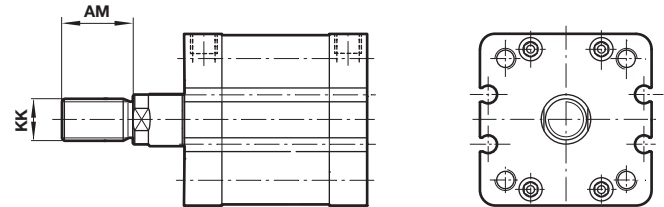
1 M/50 – Switches can be mounted flush with the profile

**RA/193000/MX – Standard cylinders
Sprung out with female piston rod thread**

**RA/193000/M – Standard cylinders
Sprung out with male piston rod thread**

Stroke

Ø	AF	AM	BG	Ø CD H11	□ E	EE	KF	KK	LA	Ø MM h9	PL
20	10	16	12	10	37	M5	M6	M8 x 1,25	2,5	10	7
25	10	16	13	10	41	M5	M6	M8 x 1,25	2,5	10	7
32	12	19	14,5	14	48	G1/8	M8	M10 x 1,25	2,5	12	7,5
40	12	19	14,5	14	54,5	G1/8	M8	M10 x 1,25	2,5	16	7,5
50	16	22	14	18	66	G1/8	M10	M12 x 1,25	2,5	20	7,5
63	16	22	14	18	76	G1/8	M10	M12 x 1,25	2,5	20	7,5

Ø	□ R	Ø RR	RT	SW	V mm stroke 0 ... 25	26 ... 50	WH	ZJ	kg at 0 mm	kg per 5 mm	Model
20	22	4,3	M5	8	17	34	6	43	0,17 kg	0,01 kg	RA/19.020/M.
25	26	4,3	M5	8	18	36	6	45	0,20 kg	0,01 kg	RA/19.025/M.
32	32,5	5,3	M6	10	19	38	7	51	0,30 kg	0,02 kg	RA/19.032/M.
40	38	5,3	M6	13	20	40	7	52	0,40 kg	0,02 kg	RA/19.040/M.
50	46,5	6,8	M8	17	30	60	8	53	0,65 kg	0,03 kg	RA/19.050/M.
63	56,5	6,8	M8	17	30	60	8	57	0,90 kg	0,03 kg	RA/19.063/M.

Cylinder variants

RA/191000/N2X

Cylinder with non-rotating piston rod
Sprung in with female piston rod thread

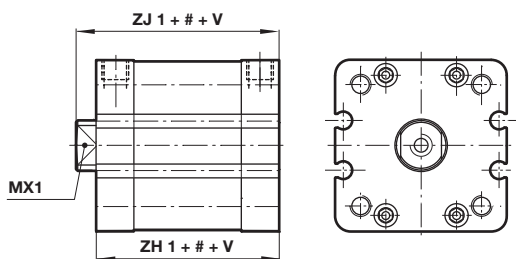

RA/191000/N2

Cylinder with non-rotating piston rod
Sprung in with male piston rod thread

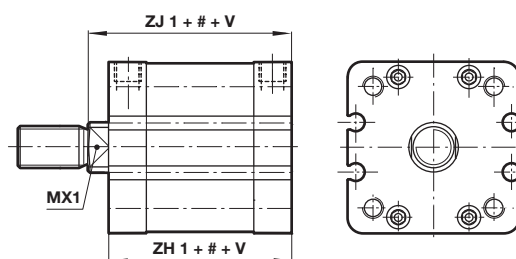

Dimensions in mm
Projection/First angle



RA/193000/N2X

Cylinder with non-rotating piston rod
Sprung out with female piston rod thread

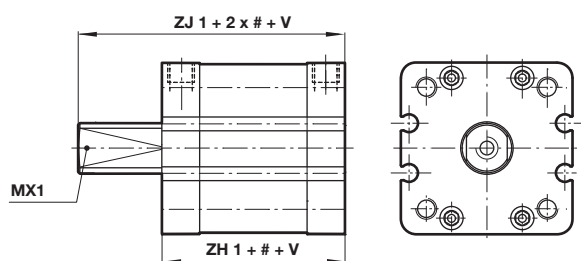

RA/193000/N2

Cylinder with non-rotating piston rod
Sprung out with male piston rod thread

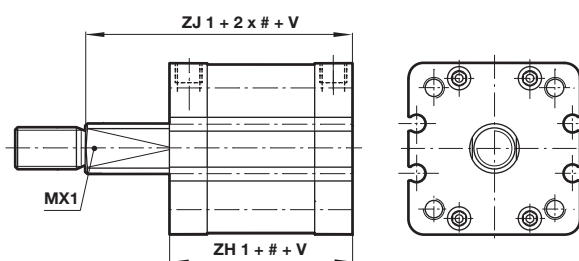

Missing cylinder dimensions, see previous page 5

Ø	MX1	V mm stroke		ZH1	ZJ1	Weight		Model
		0 ... 25	26 ... 50			at 0 mm	per 5 mm	
20	8	17	34	47	53	0,17 kg	0,01 kg	RA/19.020/N2.
25	8	18	36	49	55	0,20 kg	0,01 kg	RA/19.025/N2.
32	10	19	38	54	61	0,30 kg	0,02 kg	RA/19.032/N2.
40	13	20	40	55	62	0,40 kg	0,02 kg	RA/19.040/N2.
50	16	30	60	55	63	0,65 kg	0,03 kg	RA/19.050/N2.
63	16	30	60	59	67	0,90 kg	0,03 kg	RA/19.063/N2.

Torque for cylinders RA/19.000/N2.

Ø	Torque max. (Nm)	Model
20	0,15	RA/19*020/N2.
25	0,25	RA/19*025/N2.
32	0,40	RA/19*032/N2.
40	0,75	RA/19*040/N2.
50	1,50	RA/19*050/N2.
63	1,50	RA/19*063/N2.

Mountings

Front or rear stud mounting A Conforms to ISO 6431, type MX1

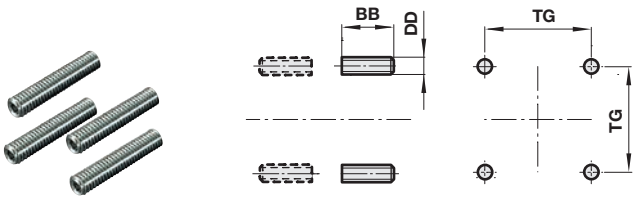

Ø	BB	DD	TG	kg	Model (A)
32/40	17	M6	32,5/38	0,02	QM/8032/35
50/63	23	M8	46,5/56,5	0,05	QM/8050/35

Front flange B, Front flange G Conforms to ISO 21 287 (Ø 20 and 25 mm) and DIN ISO 6431 or VDMA 24562 Part 2 (Ø 32 to 63 mm), Type MF1 and MF2

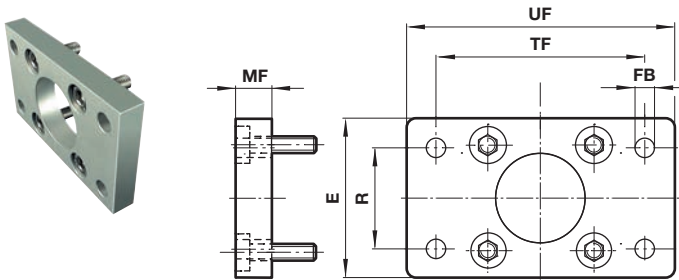

Ø	E	Ø FB	MF	R	TF	UF	kg	Model (B/G)
20	36	6,6	8	-	55	70	0,16	QA/192020/22
25	40	6,6	8	-	60	76	0,2	QA/192025/22
32	50	7	10	32	64	80	0,25	QA/8032/22
40	55	9	10	36	72	90	0,35	QA/8040/22
50	65	9	12	45	90	110	0,7	QA/8050/22
63	75	9	12	50	100	125	0,8	QA/8063/22

Rear clevis D Conforms to DIN ISO 6431 and VDMA 24562 Part 2, Type MP2

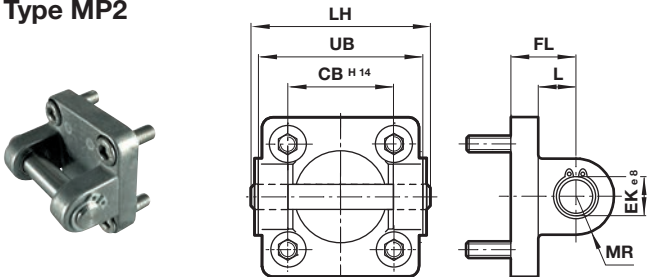

Ø	CB H14	Ø EK e8	FL	L	LH	MR	UB	kg	Model (D)
32	26	10	22	13	52	9	45	0,11	QA/8032/23
40	28	12	25	16	60	12	52	0,16	QA/8040/23
50	32	12	27	17	68	12	60	0,22	QA/8050/23
63	40	16	32	22	79	15	70	0,34	QA/8063/23

Piston rod swivel AK

Dimensions in mm
Projection/First angle

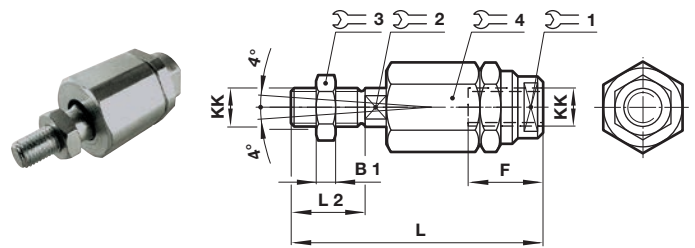

Ø	KK	B1	F	L	L2	1 2 3 4				kg	Model (AK)
						1	2	3	4		
20/25	M8x1,25	4	18	55	16	10	7	13	17	0,05	QM/8020/38
32/40	M10x1,25	5	26	73	20	19	12	17	30	0,2	QM/8025/38
50/63	M12x1,25	6	26	77	24	19	12	19	30	0,2	QM/8040/38

Foot C Conforms to ISO 21287, type MS1

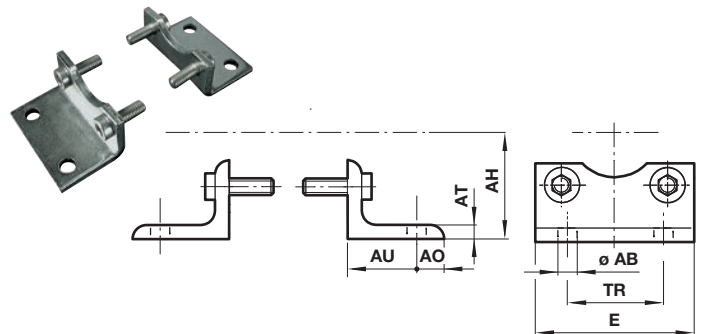

Ø	Ø AB	AH	AO	AT	AU	E	TR	kg	Model (C)
20	7	27	6	4	16	36	22	0,03	QM/192020/21
25	7	29	7	4	16	40	26	0,04	QM/192025/21
32	7	33,5	7	4	16	48	32	0,15	QA/192032/21
40	10	38	9	4	18	54,5	36	0,18	QA/192040/21
50	10	45	9	5	21	66	45	0,3	QA/192050/21
63	10	50	9	5	21	76	50	0,39	QA/192063/21

Rear clevis D2 Conforms to VDMA 24562 Part 2

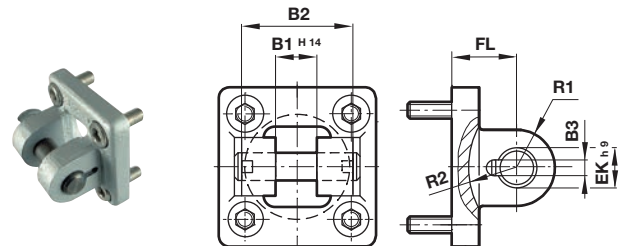

Ø	B1 H14	B2	B3	Ø EK h9	FL	R1	R2	kg	Model (D2)
32	14	34	3,3	10	22	11	17	0,20	QA/8032/42
40	16	40	4,3	12	25	12	20	0,23	QA/8040/42
50	21	45	4,3	16	27	14,5	22	0,36	QA/8050/42
63	21	51	4,3	16	32	18	25	0,55	QA/8063/42

Front or rear detachable trunnion FH
Conforms to VDMA 24562 part 2, type MT 5/6

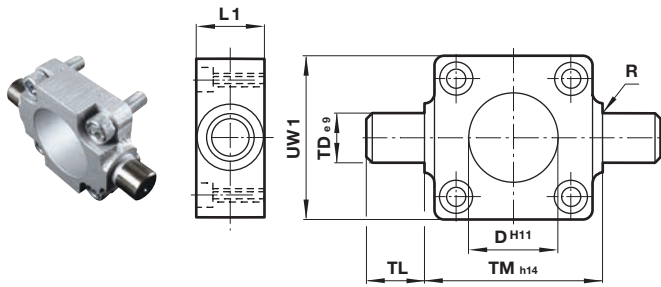

Ø	Ø D _{h11}	L1	R	Ø TD _{e9}	TL	TM _{h14}	UW1	kg	Model (FH)
32	30	16	1	12	12	50	45	0,20	QA/8032/34
40	35	20	1,6	16	16	63	55	0,38	QA/8040/34
50	40	24	1,6	16	16	75	65	0,60	QA/8050/34
63	45	24	1,6	20	20	90	75	1,10	QA/8063/34

Piston rod clevis F
Conforms to DIN ISO 8140
For cylinders with male piston rod
thread order nut, Type N2 separately

Dimensions in mm
Projection/First angle

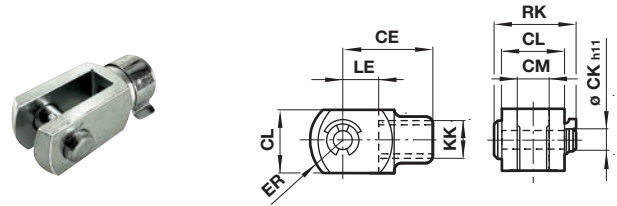

Ø	KK	CE	Ø CK _{h11}	CL	CM	ER	LE	RK	kg	Model (F)
20/25	M8x1,25	32	8	16	8	13	16	22	0,06	QM/8020/25
32/40	M10x1,25	40	10	20	10	16	20	28	0,09	QM/8025/25
50/63	M12x1,25	48	12	24	12	19	24	32	0,13	QM/8040/25

Universal piston rod eye UF
Conforms to DIN ISO 8139
For cylinders with male piston rod thread order nut,
Type N2 separately

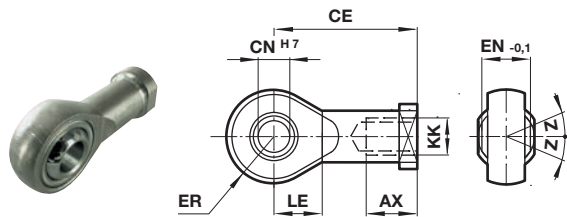

Ø	Thread KK	AX	CE	Ø CN _{H7}	EN _{-0,1}	ER	LE	Z	kg	Model (UF)
20/25	M8x1,25	16	36	8	12	11	13	5°	0,05	QM/8020/32
32/40	M10x1,25	20	43	10	14	14	15	13°	0,09	QM/8025/32
50/63	M12x1,25	22	50	12	16	16	17	13°	0,13	QM/8040/32

Rear eye R
Conforms to ISO 21 287 (Ø 20 and 25 mm) and
DIN ISO 6431 or VDMA 24562 Part 2 (Ø 32 to 63 mm),
Type MP4

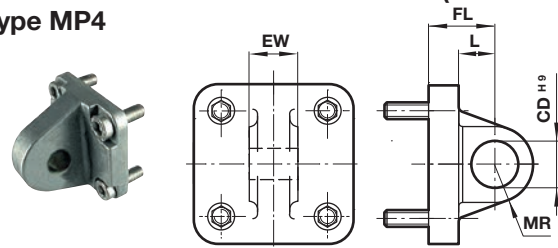

Ø	Ø CD _{H9}	EW	FL	L	MR	kg	Model (R)
20	8	15,8	20	14	8	0,02	QM/192020/27
25	8	15,8	20	14	8	0,03	QM/192025/27
32	10	25,8	22	13	9	0,09	QA/8032/27
40	12	27,8	25	16	12	0,11	QA/8040/27
50	12	31,7	27	17	12	0,17	QA/8050/27
63	16	39,7	32	22	15	0,24	QA/8063/27

Adjustable trunnion mounting UH
Conforms to DIN ISO 6431 and VDMA 24562 Part 2,
Type MT4

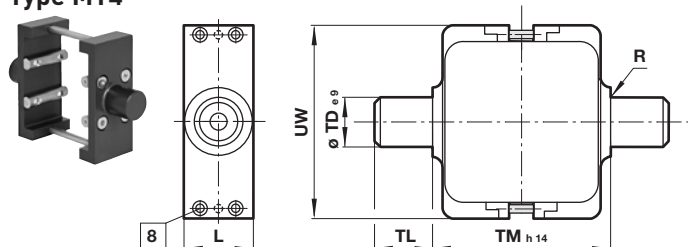

Ø	L	R	Ø De ₉	TL	TM _{h14}	UW	Torque max. (Nm)	kg	Model (UH)
32	25	1	12	12	50	58	2	0,16	PQA/182032/40
40	28	1,6	16	16	63	65	3,5	0,35	PQA/182040/40
50	28	1,6	16	16	75	80	3,5	0,65	PQA/182050/40
63	36	1,6	20	20	90	96	5	0,85	PQA/182063/40

Universal rear eye UR
Conforms to VDMA 24562 Part 2

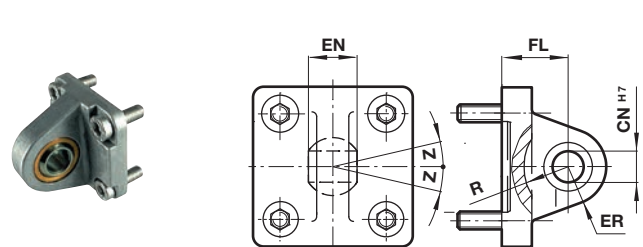

Ø	Ø CN _{H7}	EN	ER	FL	R	Z	kg	Model (UR)
32	10	14	16	22	14,5	13°	0,15	QA/8032/33
40	12	16	18	25	18	13°	0,25	QA/8040/33
50	16	21	21	27	19	15°	0,40	QA/8050/33
63	16	21	23	32	24	15°	0,55	QA/8063/33

Note: Style UH: It is most important that the locking screws which secure the mounting to the cylinder barrel are tightened to the torque figures shown in the table. For maximum energy input, consult our Technical Service.

Trunnion support S
Conforms to VDMA 24562 Part 2

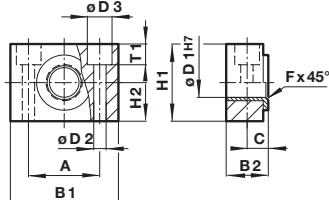

Ø	A	B1	B2	C	Ø D1 _{H7}	Ø D1	Ø D3	Fx 45°	H1	H2	T1	kg	Model (S)
32	32	46	18	10,5	12	6,6	11	1	30	15,3	6,8	0,11	QA/8032/41
40/50	36	55	21	12	16	9	15	1,6	36	18	9	0,16	QA/8040/41
63	42	65	23	13	20	11	18	1,6	40	20	11	0,23	QA/8063/41

Bracket hinge L2
For rear eye mounting R

Dimensions in mm
Projection/First angle

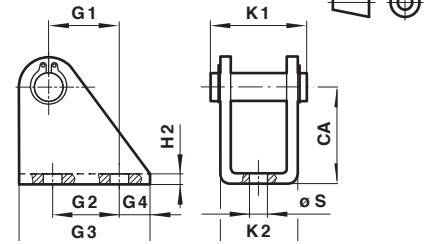

Ø	CA	G1	G2	G3	G4	H2	K1	K2	Ø S	kg	Model(L2)
20/25	30	16	20	32	6	4	29,5	24	6,6	0,08	QM/8020/44

Nut N2
For cylinder with male piston rod thread

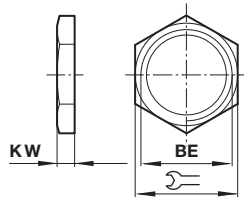

Ø	BE	KW	⌀	kg	Model(N2)
20/25	M8x1,25	4	13	0,01	M/P1501/60
32/40	M10x1,25	5	17	0,01	M/P1501/89
50/63	M12x1,25	6	19	0,01	M/P1501/90

Wide hinge SW
Conforms to ISO 15552, type AB7

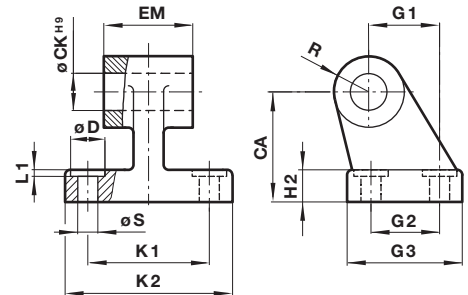

Ø	CA	Ø CK _{H9}	Ø D	H2	EM	G1	G2	G3	K1	K2	L1	R	Ø S	kg	Model (SW)
32	32	10	11	7	25,5	21	18	31	38	50	1,6	10	6,6	0,05	M/P19493
40	36	12	11	9	27,5	24	22	35	41	54	1,6	11	6,6	0,07	M/P19494
50	45	12	15	11	31,5	33	30	45	50	65	1,6	13	9	0,14	M/P19495
63	50	16	15	12	39,5	37	35	50	52	67	1,6	15	9	0,18	M/P19496

Swivel hinge US
Conforms to VDMA 24562 part 2

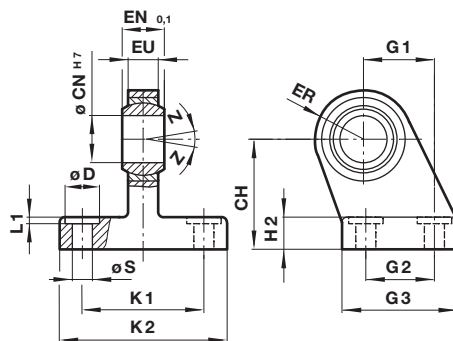

Ø	CH	Ø CN _{H7}	Ø D	EN -0,1	ER	EU	G1	G2	G3	H2	K1	K2	L1	Ø S	Z	kg	Model (US)
32	32	10	11	14	16	10,5	21	18	31	10	38	51	1,6	6,6	13°	0,19	MP40310
40	36	12	11	16	18	12	24	22	35	10	41	54	1,6	6,6	13°	0,24	MP40311
50	45	16	15	21	21	15	33	30	45	12	50	65	1,6	9	13°	0,46	MP40312
63	50	16	15	21	23	15	37	35	50	12	52	67	1,6	9	15°	0,59	MP40313

Assembly kit for four position cylinders

Dimensions in mm
Projection/First angle

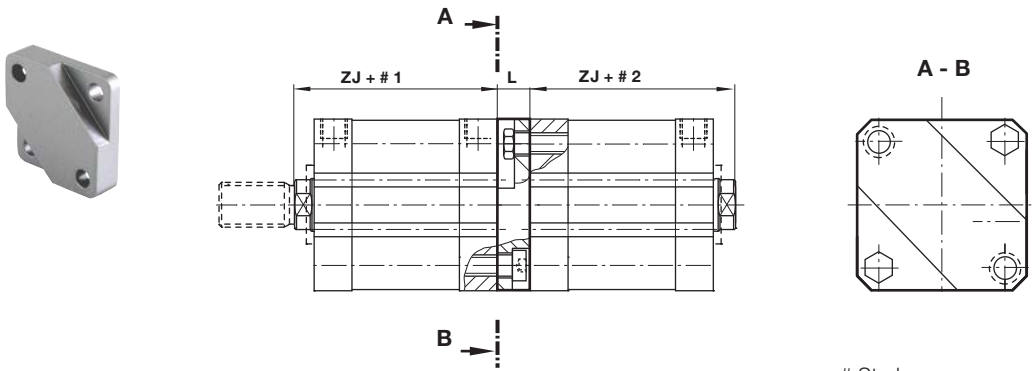

Stroke

Ø	L	ZJ	kg	Model
20	10	43	0,03	QA/192020/55
25	10	45	0,04	QA/192025/55
32	12,5	51	0,07	QA/192032/55
40	12,5	52	0,09	QA/192040/55
50	15	53	0,14	QA/192050/55
63	15	57	0,19	QA/192063/55

Groove key M/P72816
Weight: 0,01 kg

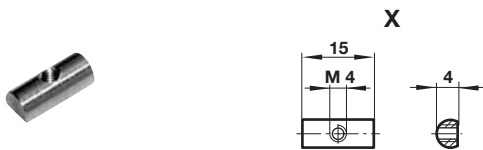

Groove cover M/P72725/1000

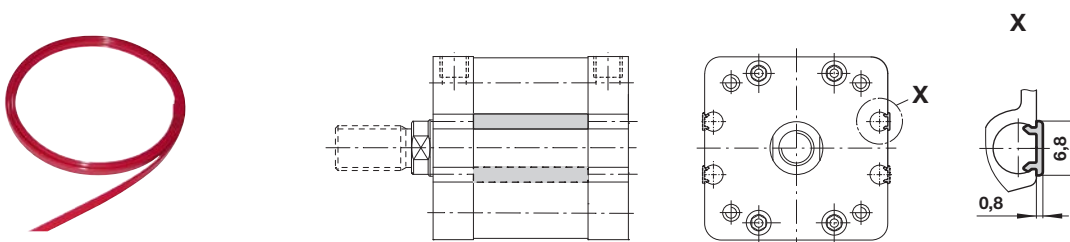

Technical data - Reed switches - additional informations see data sheet N/en 4.3.005

Symbol	Voltage		Current maximum (mA)	Function	Operating temperature (°C)	LED	Protection class	Plug	Cable length (m)	Cable type	Weight (g)	Model
	(V a.c.)	(V d.c.)										
	10 ... 240	10 ... 170	180	Closer	-25 ... +80	•	IP66	—	2, 5 or 10	PVC 2 x 0,25	37	M/50/LSU/*V
	10 ... 240	10 ... 170	180	Closer	-25 ... +80	•	IP66	—	5	PUR 2 x 0,25	37	M/50/LSU/5U
	10 ... 240	10 ... 170	180	Closer	-25 ... +150	—	IP66	—	2	Silicon 2 x 0,25	37	TM/50/RAU/2S
	10 ... 240	10 ... 170	180	Changeover	-25 ... +80	—	IP66	—	5	PVC 3 x 0,25	37	M/50/RAC/5V
	10 ... 60	10 ... 60	180	Closer	-25 ... +80	•	IP66	M8 x 1	0,3	PVC 3 x 0,25	16	M/50/LSU/CP *1)

* Insert cable length; *1) Plug-in connector see page 11; Color code: BK = black, BN = brown, BU = blue

Drawings

M/50/LSU/*V, M/50/LSU/5U,
TM/50/RAU/2S
Cable length L = 2, 5 or 10 m

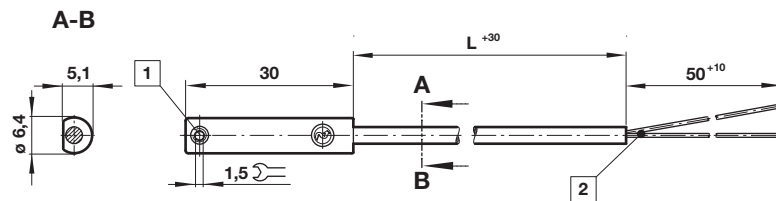

M/50/RAC/5V
Cable length L = 5 m

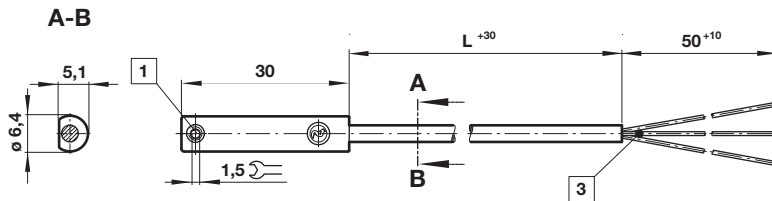

M/50/LSU/CP

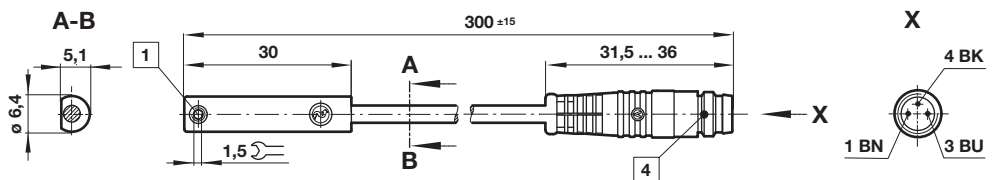

- 1 Fixing screw
- 2 + BN = brown; - BU = blue (output)
- 3 - BK = black; + BN = brown; - ≠BU = blue
- 4 Plug M8 x 1, color code: BK = black; BN = brown; BU = blue



Accessories

Plug-in connector cable with nut

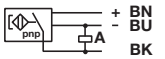
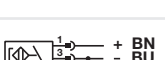
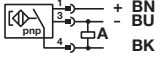

Outer cover	Cable length (m)	Weight (kg)	Connector	Connector
PVC 3 x 0,25	5 m	0,18	M8 x 1	M/P73001/5
PUR 3 x 0,25	5 m	0,18	M8 x 1	M/P73002/5
PUR 3 x 0,34	5 m	0,21	M12 x 1	M/P34594/5

Technical data - Solid state - additional informations see data sheet N/en 4.3.007

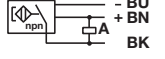
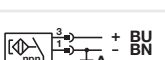
Symbol	Voltage (V d.c.)	Current maximum (mA)	Function	Operating temperature (°C)	LED	Protection class	Plug	Cable length (m)	Cable type	Weight (g)	Model
	10 ... 30	150	PNP	-40 ... +80	•	IP67	—	2, 5 or 10	PVC 3 x 0,12	37	M/50/EAP/*V
	10 ... 30	150	PNP	-40 ... +80	•	IP68	—	5	PUR 3 x 0,14	37	M/50/EAP/5U
	10 ... 30	150	PNP	-40 ... +80	•	IP67	M8 x 1	0,3	PVC 3 x 0,14	16	M/50/EAP/CP *1)
	10 ... 30	150	PNP	-40 ... +80	•	IP67	M12 x 1	0,3	PVC 3 x 0,14	16	M/50/EAP/CC *1)
	10 ... 30	150	NPN	-40 ... +80	•	IP67	—	2, 5 or 10	PVC 3 x 0,12	37	M/50/EAN/*V
	10 ... 30	150	Closer	-40 ... +80	•	IP67	M8 x 1	0,3	PVC 3 x 0,14	16	M/50/EAN/CP *1)

* Insert cable length; *1) Plug-in connector below; Color code: BK = black, BN = brown, BU = blue

Drawings

M/50/EAP/*V,
M/50/EAN/*V
Cable length L = 2, 5 or 10 m

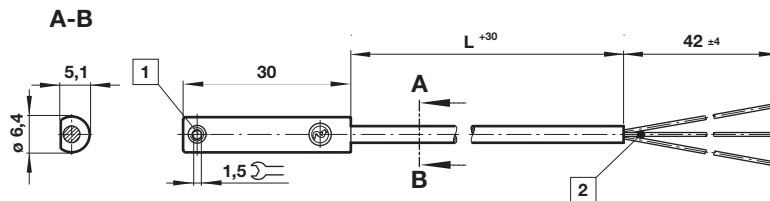

Dimensions in mm
Projection/First angle



M/50/EAP/CP,
M/50/EAN/CP

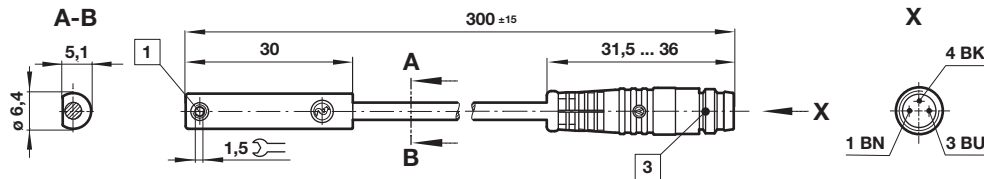

M/50/EAP/CC

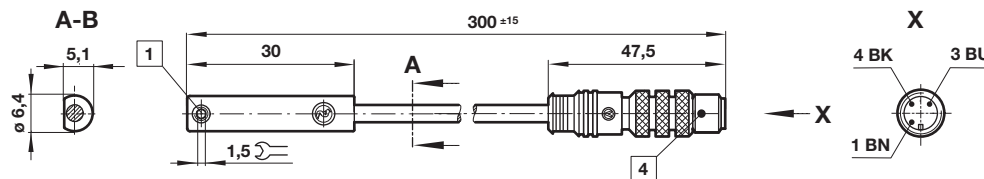

- 1 Fixing screw
- 2 Color code: BK = black; BN = brown; BU = blue
- 3 Plug M8 x 1
- 4 Plug M12 x 1

Warning

These products are intended for use in industrial compressed air systems only. Do not use these products where pressures and temperatures can exceed those listed under

»Technical features/data«.

Before using these products with fluids other than those specified, for non-industrial applications, life-support systems or other applications not within published specifications, consult IMI NORGREN.

Through misuse, age, or malfunction, components used in fluid power systems can fail in various modes.

The system designer is warned to consider the failure modes of all component parts used in fluid power systems and to provide adequate safeguards to prevent personal injury or damage to equipment in the event of such failure.

System designers must provide a warning to end users in the system instructional manual if protection against a failure mode cannot be adequately provided.

System designers and end users are cautioned to review specific warnings found in instruction sheets packed and shipped with these products.