

PRK49C RELAIS Retro-reflective photoelectric sensors with polarization filter

en 02-2015/08 50128460-01

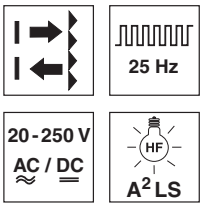

30m

- Polarized retro-reflective photoelectric sensor with large operating range and high performance reserve in visible red light
- Reliable detection of glossy objects and objects shrink-wrapped in foil
- Variants available without polarization filter with infrared light
- Robust plastic housing, degree of protection IP 67 and IP 69K for industrial application
- All-mains design 20 ... 250VAC/DC with relay output (potential-free)
- Sensitivity adjustment and delay before start-up for optimal adaptation to the application
- Light/dark switching and time module activation via teach button for time-saving integration in existing evaluation environment:
- Space-saving installation thanks to front access to the connection compartment
- Extremely time-saving connection by means of spring terminals (up to 1.5mm²)
- Optics heating



Accessories:

(available separately)

- Mounting systems (BTU 460, BT 96, BT 96.1, BT 450.1-96)
- Spark extinction
- Reflectors/reflective tapes

Dimensioned drawing

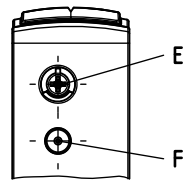
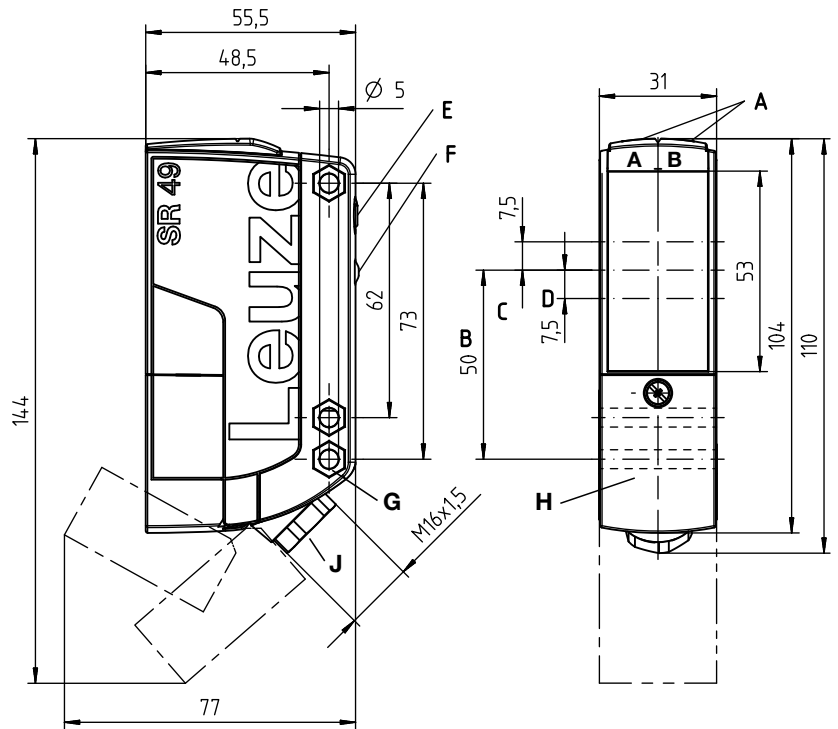

- A_A** Green indicator diode
- A_B** Yellow indicator diode
- B** Optical axis
- C** Receiver
- D** Transmitter
- E** Sensitivity adjustment
- F** Teach button for light/dark switching / time module activation
- G** Countersinking for SK nut M5, 4.2 deep
- H** Connection compartment with spring terminals
- J** Cable entry with M16x1.5 screw fitting for Ø5 ... 10mm

Electrical connection

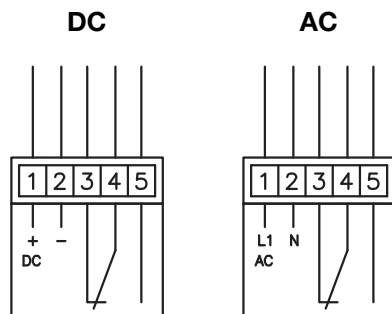

Wire color of connecting cable

Pin	Color
1	BR / BN
2	BL / BU
3	WS / WH
4	GR / GY
5	SW / BK

We reserve the right to make changes • DS_PRK49CUCCTS_en_50128460_01.fm

Specifications

Optical data

Typ. op. range limit (TK(S) 100x100) ¹⁾
 Operating range ²⁾
 Light spot diameter
 Light source
 Wavelength
 Polarization filter

PRK49C...

30m
 see tables
 approx. 130mm at 6m
 LED (modulated light)
 630nm (visible red light)
 yes

RK49C...

880nm (infrared light)
 no

Timing

Switching frequency
 Response time
 Delay before start-up

25Hz
 20ms
 ≤ 300ms

Electrical data

Operating voltage U_B

20 ... 250VAC, 50/60Hz
 20 ... 250VDC

Power consumption
 Switching output ³⁾
 Function
 Switching voltage, relay
 Switching current, relay
 Switching power, relay
 Sensitivity

≤ 1.5VA
 relay, 1 change-over contact
 break-contact/make-contact
 250VAC/DC
 250VAC, 2.5A/30VDC, 2.5A
 625VA, $\cos\phi=1$
 adjustable

Indicators

Green LED
 Yellow LED
 Yellow LED, flashing

ready
 light path free
 light path free, no performance reserve

Mechanical data

Housing
 Optics cover
 Weight
 Connection type

polycarbonate
 plastic
 150g
 spring terminals, max. wire cross section 1.5mm²
 cable 2000mm, 5 x 0.5mm²

Environmental data

Ambient temp. (operation/storage)
 Protective circuit ⁴⁾
 VDE safety class ⁵⁾
 Degree of protection
 Light source
 Standards applied

-40°C ... +60°C/-40°C ... +70°C
 1, 4
 II, all-insulated
 IP 67, IP 69K ⁶⁾
 exempt group (in acc. with EN 62471)
 IEC 60947-5-2

Options

Switching function (teach level 1)
 Time module (teach level 2)

light switching (factory setting) or dark switching
 active: dropout delay 500ms
 not active:no dropout delay (factory setting)

Optics heating

Current consumption

approx. 70mA at 20VDC

- 1) Typ. operating range limit: max. attainable range without performance reserve
- 2) Operating range: recommended range with performance reserve
- 3) Suitable spark extinction (snubber) must be provided with inductive or capacitive loads
- 4) 1=transient protection, 4=interference blanking
- 5) Rating voltage 250VAC
- 6) IP 69K test acc. to DIN 40050 part 9 simulated, high pressure cleaning conditions without the use of additives, acids and bases are not part of the test

Tables

Reflectors			Operating range
1	TK(S)	100x100	0.3 ... 24m
2	MTK(S)	50x50	0.3 ... 15m
3	TK(S)	30x50	0.3 ... 12m
4	TK(S)	20x40	0.3 ... 8m
5	TK(S)	82	0.3 ... 15m
6	Tape 4	50x50	0.3 ... 4m

1	0.1		24	30
2	0.1		15	18
3	0.1	12	15	
4	0.1	8	10	
5	0.1		15	18
6	0.1	4	5	

Operating range [m]
 Typ. operating range limit [m]

Diagrams

(only PRK49C...)

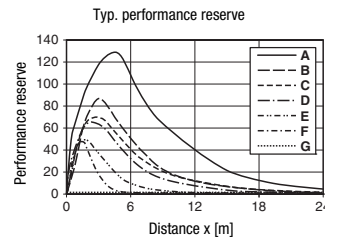
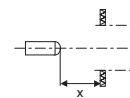
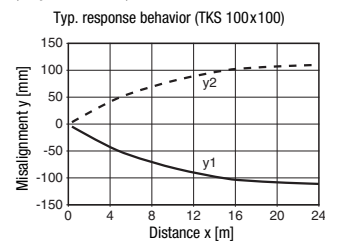

- A TK 100x100
- B TK 82.AT
- C MTKS 50x50.1
- D TKS 40x60
- E TKS 20x40
- F Tape 4 50x50
- G Switching point

Remarks

Operate in accordance with intended use!

- ☞ This product is not a safety sensor and is not intended as personnel protection.
- ☞ The product may only be put into operation by competent persons.
- ☞ Only use the product in accordance with the intended use.

PRK49C RELAIS Retro-reflective photoelectric sensors with polarization filter

Part number code

P R K 4 9 C I . U C D 1 / T S - T B

Operating principle

- RK** Retro-reflective photoelectric sensor
- PRK** Retro-reflective photoelectric sensors with polarization filter

Series

- 49C** 49C series

Light type

- I** Infrared light
- free** Red light

Operating voltage

- UC** 20 ... 250VAC/DC (all-mains design)

Equipment

- D** Depolarizing media
- H** Optics heating

Setting

- 1** Potentiometer, teach button (light/dark switching, time module activation)

Switching output

- TS** Relay, normally closed contact/normally open contact (NC/NO)
- M4** Low-impedance MOSFET semiconductor switching output, normally open contact (NO)

Connection technology

- TB** Terminal block - terminal compartment with spring terminals (5 x 1.5mm²)
- free** Cable 2000mm

Order guide

The sensors listed here are preferred types; current information at www.leuze.com.

All-mains designs with relay output

Designation

Part no.

Terminal compartment with spring terminals (5 x 1.5mm²)

Red light, polarization filter	PRK49C.UC/TS-TB	50127422
Red light, polarization filter, optics heating	PRK49C.UCH/TS-TB	50130468
Red light, polarization filter, potentiometer, teach button	PRK49C.UC1/TS-TB	50127420
Red light, polarization filter, depolarizing media, potentiometer, teach button	PRK49C.UCD1/TS-TB	50127426
Infrared light	RK49CI.UC/TS-TB	50127428

Cable, cable length 2m

Red light, polarization filter, potentiometer, teach button	PRK49C.UC1/TS	50127421
Red light, polarization filter, depolarizing media, potentiometer, teach button	PRK49C.UCD1/TS	50127427

Teach procedure for sensor



Note

Factory setting: **light switching, time module not active**

Light/dark switching

Setting the switching behavior of the relay output

Teach level 1	<p>Press teach button (2 to 7s) until both LEDs (green/yellow) flash synchronously. Release teach button – switchover is complete.</p> <p>The yellow LED then indicates the current setting of the switching output for 3s:</p> <p>ON = light switching = output between pin 4 and pin 3: normally closed contact (NC) output between pin 4 and pin 5: normally open contact (NO)</p> <p>OFF = dark switching = output between pin 4 and pin 3: normally open contact (NO) output between pin 4 and pin 5: normally closed contact (NC)</p>	<p>2 ... 7s</p>
----------------------	---	-----------------

Activation/deactivation of the time module

Setting a dropout delay for the relay output

Teach level 2	<p>Press teach button (7 to 12s) until both LEDs (green/yellow) flash alternately. Release teach button – activation/deactivation is complete.</p> <p>The yellow LED then indicates the current setting of the dropout delay for 3s:</p> <p>ON = time module not active = no dropout delay for the relay</p> <p>OFF = time module active = dropout delay for the relay: 500ms ¹⁾</p> <p><small>1) Additional models on request</small></p>	<p>7 ... 12s</p>
----------------------	--	------------------

Dropout delay: if the object is no longer present, the output switches with a time delay.