

Multifunction time delay relay

MFT IU14S, IU24S



MFT IU14S

- **7 functions**
- **Zoomvoltage:**
12 ... 240 Vac/dc
- **2 output contacts**

Function

U Multifunction

- E** Delay on
- A** Delay off
- I2** Pulse extension with control contact
- W2** Wiping on trailing edge
- E1** Delay on with control contact
- I1** Pulse limitation timer voltage control
- B2** Cycling timer starting on a pause



MFT IU24S

Time ranges

Adjustable 0,05 s ... 100 h

Output relay

1 or 2 changers potential free 250 Vac / 8 A

Indicators

- Green LED ON: indication of supply voltage
- Green LED flashes: indication of time
- Yellow LED ON/OFF: indication of relay output

Supply voltage

12... 240 Vac/dc -10% +10%

AC 48 ... 63 Hz, 100% duration of operation

Reference data

| Selectron® MFT | Article no. |
|----------------------------|-------------|
| MFT IU14S | 41130003 |
| MFT IU24S | 41130004 |
| (Order data see chapter 1) | |

Multifunction time delay relay

MFT IU14S, IU24S

| Technical data | |
|---|---|
| Input circuit | MFT IU143S, IU24S |
| | 12 ... 240 Vac/dc |
| | IU14S: 4 VA / 1,5 W IU24S: 6 VA / 2 W |
| | Residual ripple for dc 10% |
| | Drop-out voltage >30% of minimum rated supply voltage |
| Control contact / Voltage controlled | |
| | Parallel switching of loads possible |
| | Input not potential free terminals A1 - B1 |
| | Trigger level (sensitivity) automatic adapted to supply voltage |
| | Max. line length 10 m |
| | Min. control pulse length DC 50 ms / AC 100 ms |
| Accuracy | |
| | Base accuracy ±1% of the scale limit |
| | Repeatability of the scale limit <0,5% or ±5 ms |
| | Adjustment accuracy <5% of the scale limit |
| | Temperature influence ≤0,01% / °C |
| Reaction times | |
| | Recovery time 100 ms |

Type key

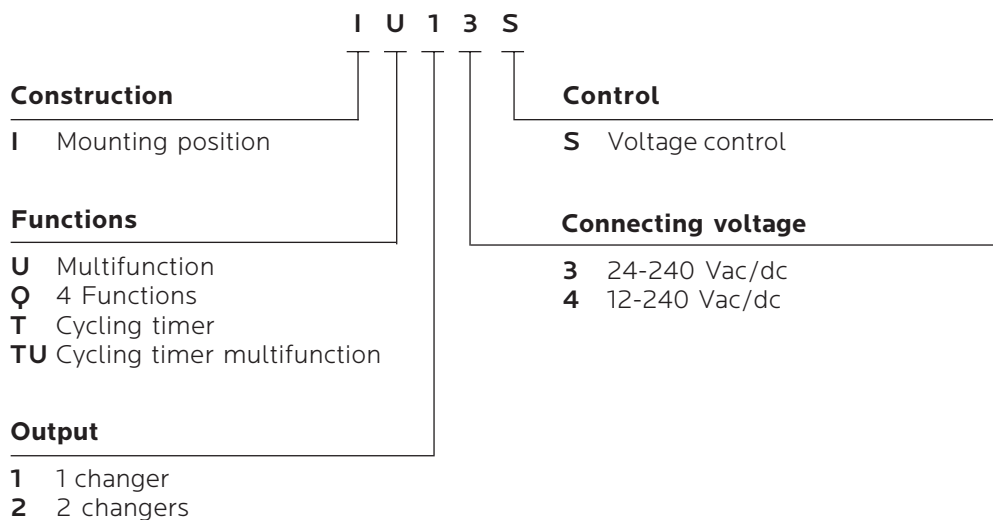

Multifunctional time delay relay

MFT IU14S, IU24S

Function descriptions

E - Delay on

When the supply voltage U is applied, the set interval t begins (green LED U/t flashes). After the interval t has expired



(green LED U/t illuminated) the output relay switches into on-position (yellow LED illuminated). This status remains until the supply voltage U is interrupted. If the supply voltage U is interrupted before expiry of the interval t, the interval already expired is erased and is restarted when the supply voltage U is next applied.

A - Delay off

The supply voltage U must be constantly applied to the device (green LED U/t illuminated). When the control contact

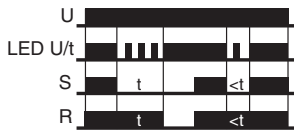

S is closed, the output relay R switches into on-position (yellow LED illuminated). If the control contact S is opened, the set interval t begins (green LED U/t flashes). After the interval t has expired (green LED U/t illuminated) the output relay switches into off-position (yellow LED not illuminated). If the control contact is closed again before the interval t (green LED U/t illuminated) has expired, the interval already expired is erased and is restarted with the next cycle.

I2 - Pulse extension with control contact

The supply voltage U must be constantly applied to the device (green LED U/t illuminated). When the control contact

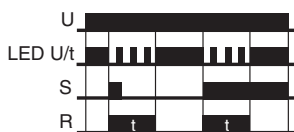

S is closed, the output relay R switches into on-position (yellow LED illuminated) and the set interval t begins (green LED U/t flashes). After the interval t has expired (green LED U/t illuminated) the output relay switches into off-position (yellow LED not illuminated). During the interval, the control contact can be operated any number of times. A further cycle can only be started when the cycle run has been completed.

W2 - Wiping on trailing edge

The supply voltage U must be constantly applied to the device (green LED U/t illuminated). Closing the control

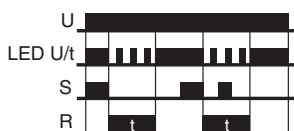

contact S has no influence on the condition of the output relay R. When the control contact is opened, the output relay switches into on-position (yellow LED illuminated) and the set interval t begins (green LED U/t flashes). After the interval t has expired (green LED U/t illuminated), the output relay switches into off-position (yellow LED not illuminated). During the interval, the control contact can be operated any number of times. A further cycle can only be started when a cycle run has been completed.

E1 - Delay on with control contact

The supply voltage U must be constantly applied to the device (green LED U/t illuminated). When the control contact



S is closed, the set interval t begins (green U/tLED flashes). After the interval t has expired (green LED U/t illuminated) the output relay R switches into on-position (yellow LED illuminated). This status remains until the control contact is opened. If the control contact is opened before the interval t has expired, the interval already expired is erased and is restarted with the next cycle.

I1 - Pulse limitation timer voltage control

When supply voltage U is applied, the output relay R switches into on-position (yellow LED illuminated) and the set interval t

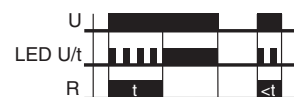

begins (green LED U/t flashes). After the interval t has expired (green LED U/t illuminated) the output relay switches into off-position (yellow LED not illuminated). This status remains until the supply voltage is interrupted. If the supply voltage is interrupted before the interval t has expired, the output relay switches into off-position. The interval t already expired is erased and is restarted when the supply voltage is next applied.

B2 - Cycling timer starting on a pause

When the supply voltage U is applied, the set interval t begins (green LED U/t flashes). After the interval t has expired, the



output relay R switches into on-position (yellow LED illuminated) and the set interval t begins again. After the interval t has expired, the output relay switches into off-position (yellow LED not illuminated). The output relay is triggered in the ratio 1:1 until the supply voltage is interrupted.

Multifunctional time delay relay

MFT IU14S, IU24S

Connection

MFT IU14S

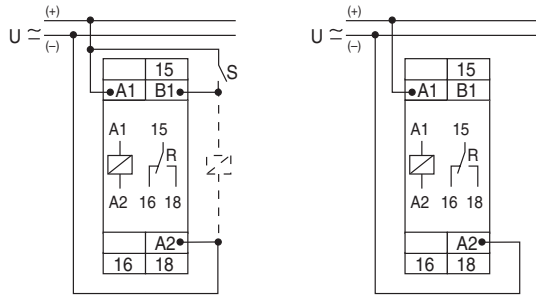

MFT IU24S

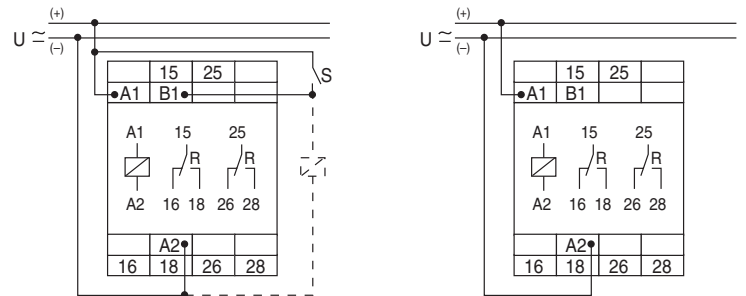

Load limit curves

MFT IU14S

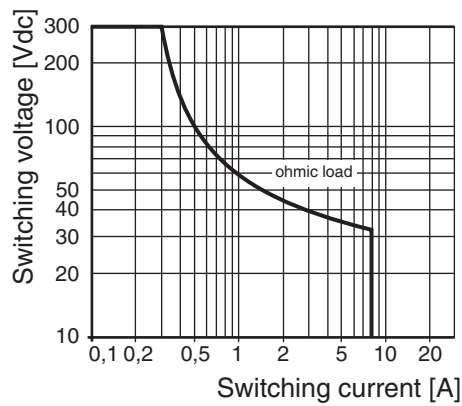

MFT IU24S

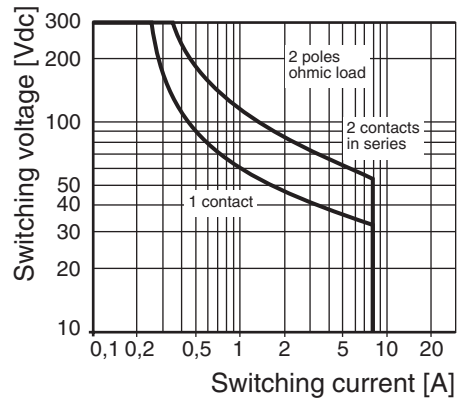

Dimensions

