

Technical Data

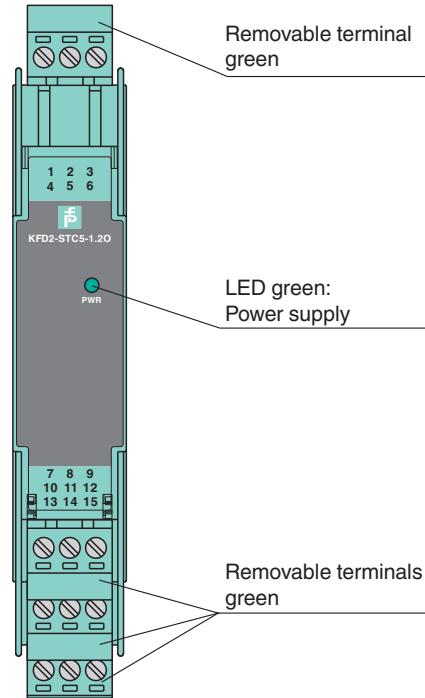





Power consumption	≤ 1.7 W at maximum load
Input	
Connection side	field side
Connection	terminals 1+, 2-, 3
Input signal	0/4 ... 20 mA
Open circuit voltage/short-circuit current	terminals 1+, 3: 23 V / 25 mA
Input resistance	max. 265 Ω terminals 2-, 3 , max. 330 Ω terminals 1+, 3
Available voltage	≥ 16 V at 20 mA ; ≥ 20 V at 4 mA , terminals 1+, 3
Output	
Connection side	control side
Connection	terminals 7+, 8-, 9-; 10+, 11-, 12- (sink) terminals 7-, 8+, 9+; 10-, 11+, 12+ (source) see additional information
Load	0 ... 600 Ω
Output signal	0/4 ... 20 mA (overload > 25 mA)
Ripple	max. 50 μA _{eff}
External supply (loop)	2 ... 30 V DC
Transfer characteristics	
Deviation	at 20 °C (68 °F), 0/4 ... 20 mA ≤ ± 10 μA incl. calibration, linearity, hysteresis, loads and supply voltage fluctuations
Influence of ambient temperature	≤ 0.25 μA/K
Frequency range	input in output: bandwidth with 1 mA _{pp} signal 0 ... 7.5 kHz (-3 dB) output in input: band width with 1 V _{ss} signal 0.3 ... 7.5 kHz (-3 dB)
Settling time	200 μs
Rise time/fall time	100 μs
Galvanic isolation	
Input/Output	basic insulation according to IEC 61010-1, rated insulation voltage 300 V _{eff}
Input/power supply	basic insulation according to IEC 61010-1, rated insulation voltage 300 V _{eff}
Output/power supply	functional insulation, rated insulation voltage 50 V AC
Output/Output	functional insulation, rated insulation voltage 50 V AC
Indicators/settings	
Display elements	LED
Labeling	space for labeling at the front
Directive conformity	
Electromagnetic compatibility	
Directive 2014/30/EU	EN 61326-1:2013 (industrial locations)
Conformity	
Electromagnetic compatibility	NE 21:2012 EN 61326-3-2:2008
Degree of protection	IEC 60529:2001
Protection against electrical shock	UL 61010-1:2012
Ambient conditions	
Ambient temperature	-20 ... 70 °C (-4 ... 158 °F)
Mechanical specifications	
Degree of protection	IP20
Connection	screw terminals
Mass	approx. 150 g
Dimensions	20 x 124 x 115 mm (0.8 x 4.9 x 4.5 inch) (W x H x D) , housing type B2
Mounting	on 35 mm DIN mounting rail acc. to EN 60715:2001
General information	
Supplementary information	Observe the certificates, declarations of conformity, instruction manuals, and manuals where applicable. For information see www.pepperl-fuchs.com .

Assembly



Front view



Matching System Components

	KFD2-EB2	Power Feed Module
	UPR-03	Universal Power Rail with end caps and cover, 3 conductors, length: 2 m
	UPR-03-M	Universal Power Rail with end caps and cover, 3 conductors, length: 1,6 m
	UPR-03-S	Universal Power Rail with end caps and cover, 3 conductors, length: 0.8 m
	K-DUCT-GY	Profile rail, wiring comb field side, gray
	K-DUCT-GY-UPR-03	Profile rail with UPR-03-* insert, 3 conductors, wiring comb field side, gray

Accessories

	KF-ST-5GN	Terminal block for KF modules, 3-pin screw terminal, green
	KF-STP-5GN	Terminal block for KF modules, 3-pin screw terminal, with test sockets, green
	KF-CP	Red coding pins, packaging unit: 20 x 6

Release date: 2021-11-29 Date of issue: 2021-11-29 Filename: 239215_eng.pdf

Refer to "General Notes Relating to Pepperl+Fuchs Product Information".

Application

The device supports the following SMART protocols:

- HART
- BRAIN
- Foxboro

Connection

The device provides 2 outputs on the control side terminals. These outputs can be operated in any combination of the current sink operating mode and current source operating mode. Please refer to the following diagram for connection.

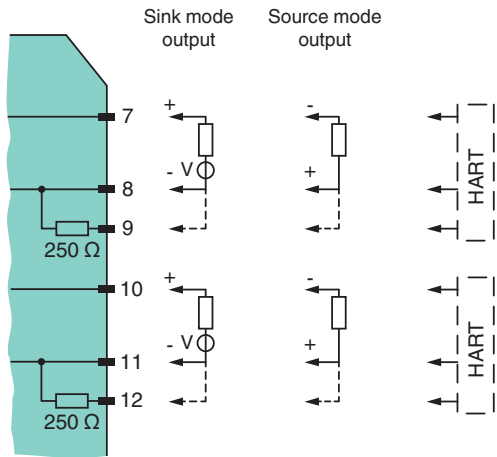

Short circuit unused circuits on the output. Open circuit outputs increase the internal power dissipation by up to 300 mW per channel.

Release date: 2021-11-29 Date of issue: 2021-11-29 Filename: 239215_eng.pdf

Refer to "General Notes Relating to Pepperl+Fuchs Product Information".