



5 2 2 3

**Programmable
f/I - f/f Converter**

No. 5223V103-UK
From ser. no. 040029001



ATEX 

- DK** ▶ PR electronics A/S tilbyder et bredt program af analoge og digitale signalbehandlingsmoduler til industriel automation. Programmet består af Isolatorer, Displays, Ex-barrierer, Temperaturtransmittere, Universaltransmittere mfl. Vi har modulerne, du kan stole på i selv barske miljøer med elektrisk støj, vibrationer og temperaturudsving, og alle produkter opfylder de strengeste internationale standarder. Vores motto »Signals the Best« er indbegrebet af denne filosofi - og din garanti for kvalitet.
- UK** ▶ PR electronics A/S offers a wide range of analog and digital signal conditioning devices for industrial automation. The product range includes Isolators, Displays, Ex Interfaces, Temperature Transmitters, and Universal Devices. You can trust our products in the most extreme environments with electrical noise, vibrations and temperature fluctuations, and all products comply with the most exacting international standards. »Signals the Best« is the epitome of our philosophy - and your guarantee for quality.
- FR** ▶ PR electronics A/S offre une large gamme de produits pour le traitement des signaux analogiques et numériques dans tous les domaines industriels. La gamme de produits s'étend des transmetteurs de température aux afficheurs, des isolateurs aux interfaces SI, jusqu'aux modules universels. Vous pouvez compter sur nos produits même dans les conditions d'utilisation sévères, p.ex. bruit électrique, vibrations et fluctuations de température. Tous nos produits sont conformes aux normes internationales les plus strictes. Notre devise »SIGNALS the BEST« c'est notre ligne de conduite - et pour vous l'assurance de la meilleure qualité.
- DE** ▶ PR electronics A/S verfügt über ein breites Produktprogramm an analogen und digitalen Signalverarbeitungsgeräte für die industrielle Automatisierung. Dieses Programm umfasst Displays, Temperaturtransmitter, Ex- und galvanische Signaltrenner, und Universalgeräte. Sie können unsere Geräte auch unter extremen Einsatzbedingungen wie elektrisches Rauschen, Erschütterungen und Temperaturschwingungen vertrauen, und alle Produkte von PR electronics werden in Übereinstimmung mit den strengsten internationalen Normen produziert. »Signals the Best« ist Ihre Garantie für Qualität!

PROGRAMMABLE f/I - f/f CONVERTER

PREcon type 5223

CONTENTS

| | |
|-----------------------------------|----|
| Warning..... | 2 |
| Symbol identification | 3 |
| Safety instructions..... | 3 |
| How to demount system 5000 | 5 |
| In general | 6 |
| Applications..... | 7 |
| Technical characteristics..... | 7 |
| Inputs..... | 7 |
| Analogue output..... | 7 |
| Digital output(s)..... | 8 |
| Relay outputs..... | 8 |
| Status indication | 8 |
| Electrical specifications..... | 9 |
| Order | 13 |
| 5223 connection to Loop Link..... | 13 |
| Block diagram 5223A | 14 |
| Block diagram 5223B | 15 |



GENERAL

WARNING

This device is designed for connection to hazardous electric voltages. Ignoring this warning can result in severe personal injury or mechanical damage. To avoid the risk of electric shock and fire, the safety instructions of this manual must be observed and the guidelines followed. The specifications must not be exceeded, and the device must only be applied as described in the following. Prior to the commissioning of the device, this manual must be examined carefully. Only qualified personnel (technicians) should install this device. If the equipment is used in a manner not specified by the manufacturer, the protection provided by the equipment may be impaired.



**HAZAR-
DOUS
VOLTAGE**

WARNING

Until the device is fixed, do not connect hazardous voltages to the device. The following operations should only be carried out on a disconnected device and under ESD safe conditions:

- Dismantlement of the device for setting of DIP-switches and jumpers.
- General mounting, connection and disconnection of wires.
- Troubleshooting the device.

Repair of the device and replacement of circuit breakers must be done by PR electronics A/S only.



**INSTAL-
LATION**

WARNING

To keep the safety distances, the device must neither be connected to hazardous nor non-hazardous voltages on the same device's relay contacts. SYSTEM 5000 must be mounted on DIN rail according to DIN 46277. The communication connector of SYSTEM 5000 is connected to the input terminals on which dangerous voltages can occur, and it must only be connected to the programming unit Loop Link by way of the enclosed cable.

SYMBOL IDENTIFICATION



Triangle with an exclamation mark: Warning/demand. Potentially lethal situations.



The CE mark proves the compliance of the device with the essential requirements of the directives.



The double insulation symbol shows that the device is protected by double or reinforced insulation.



Ex devices have been approved acc. to the ATEX directive for use in connection with installations in explosive areas.

SAFETY INSTRUCTIONS

DEFINITIONS

Hazardous voltages have been defined as the ranges: 75 to 1500 Volt DC, and 50 to 1000 Volt AC.

Technicians are qualified persons educated or trained to mount, operate, and also troubleshoot technically correct and in accordance with safety regulations.

Operators, being familiar with the contents of this manual, adjust and operate the knobs or potentiometers during normal operation.

RECEIPT AND UNPACKING

Unpack the module without damaging it. The packing should always follow the module until this has been permanently mounted. Check at the receipt of the module whether the type corresponds to the one ordered.

ENVIRONMENT

Avoid direct sunlight, dust, high temperatures, mechanical vibrations and shock, as well as rain and heavy moisture. If necessary, heating in excess of the stated limits for ambient temperatures should be avoided by way of ventilation.

All devices fall under Installation Category II, Pollution Degree 1, and Insulation Class II.

MOUNTING

Only technicians who are familiar with the technical terms, warnings, and instructions in the manual and who are able to follow these should connect the device.

Should there be any doubt as to the correct handling of the device, please contact your local distributor or, alternatively,

PR electronics A/S
www.prelectronics.com

Mounting and connection of the device should comply with national legislation for mounting of electric materials, i.e. wire cross section, protective fuse, and location. Descriptions of input / output and supply connections are shown in the block diagram and side label.

The following apply to fixed hazardous voltages-connected devices:

The max. size of the protective fuse is 10 A and, together with a power switch, it should be easily accessible and close to the device. The power switch should be marked with a label telling it will switch off the voltage to the device.

Year of manufacture can be taken from the first two digits in the serial number.

CALIBRATION AND ADJUSTMENT

During calibration and adjustment, the measuring and connection of external voltages must be carried out according to the specifications of this manual. The technician must use tools and instruments that are safe to use.

NORMAL OPERATION

Operators are only allowed to adjust and operate devices that are safely fixed in panels, etc., thus avoiding the danger of personal injury and damage. This means there is no electrical shock hazard, and the device is easily accessible.

CLEANING

When disconnected, the device may be cleaned with a cloth moistened with distilled water.

LIABILITY

To the extent the instructions in this manual are not strictly observed, the customer cannot advance a demand against PR electronics A/S that would otherwise exist according to the concluded sales agreement.

HOW TO DEMOUNT SYSTEM 5000

First, remember to demount the connectors with hazardous voltages. By lifting the bottom lock, the device is detached from the DIN rail as shown in picture 1.

Then, by lifting the upper lock and pulling the front plate simultaneously, the PCB is removed as shown in picture 2.

Switches and jumpers can now be adjusted. By opening the front, the programming connector is accessible as shown in picture 3.

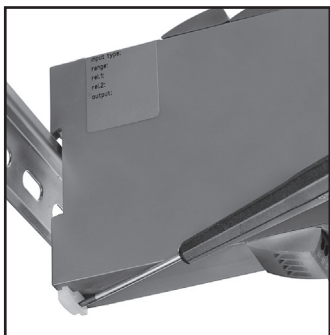

Picture 1: Separation from DIN rail.

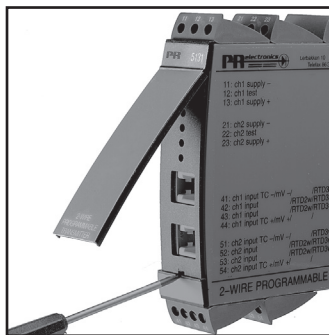

Picture 3: Access to programming connector.

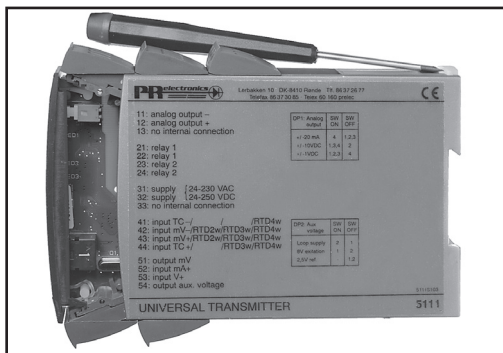

Picture 2: Removal of PCB.

PROGRAMMABLE f/I - f/f CONVERTER 5223

- *Pulse calculator*
- *Frequency generator*
- *Galvanic isolation, optional ATEX Ex*
- *Analogue current and voltage output*
- *PNP / NPN output, optional relays*
- *Universal supply*

| | |
|------------------------|--|
| Supply voltage: | 24...250 VDC 24...230 VAC |
|------------------------|--|

INPUT RANGE:

| | |
|----------------------|--|
| Frequency: | 0...20000 Hz |
| Sensor types: | Namur, tacho, NPN, PNP, TTL, SO |

OUTPUT RANGE:

| | |
|---|-----------------------------|
| Current and voltage output: | 0...20 mA / 0...10 V |
| Relay outputs: | 0...20 Hz |
| NPN and PNP output as f/f: | 0...1000 Hz |
| NPN and PNP output as generator: | 0...20000 Hz |

IN GENERAL

By way of a standard PC and the Loop Link programming kit, the PRecon 5223 f/I - f/f converter is configured acc. to the requested function.

Alternatively, the 5223 may be delivered fully-configured acc. to your specifications, see the options index in the data sheet.

Typical pulse sources are flow meters, tacho generators, mechanical switches, or inductive proximity sensors.

APPLICATIONS

The f/I function performs frequency to current and voltage conversion. The output can be programmed to show period, meaning that the input frequency can be converted to a linear time signal.

The digital outputs are used as e.g. a frequency watch for speed control or as a window comparator having one status between 2 limits and the opposite status outside these limits.

The f/f function can be used for pulse division or multiplication and as a buffer collecting fast pulse trains. The input pulses are calculated, counted in a buffer, and sent to the output as a pulse train with the programmed pulse width.

A scale factor may be entered in all functions. Using both digital inputs, pulse addition or subtraction are possible. This function permits readout of the actual consumption at measurement of e.g. liquid flows forward and backward.

The frequency generator function is used as e.g. a time base or clock generator.

The 2-phase encoder, or directional f/I conversion, converts 2 90°-phased digital inputs to an analogue speed signal with digital output for directional indication.

ATEX Ex units have input for mechanical contact and NAMUR inductive proximity sensor.

TECHNICAL CHARACTERISTICS

INPUTS

2 programmable inputs for standard pulse generator connection.

Normally, the auxiliary supply and trigger level follow the sensor type, but these can be programmed to other values.

At contact input, the 50 Hz filter should be applied.

The PRecon 5223 is protected against polarity reversal on input and supply.

ANALOGUE OUTPUT

The current and voltage signals are galvanically separated from the supply and the inputs.

The analogue current and voltage output can be scaled acc. to your choice in relation to the digital input. Max. zero offset is 50% of selected measurement range. Programmable response time.

Short-circuit-protected output.

When both current and voltage signals are used simultaneously, the mA loop to ground must pass through the internal shunt.

Standard voltage output (pin 12) is obtained by leading the current signal (pin 13) through an internal shunt resistor (pin 12). At voltage signals in the ranges 0...1 VDC, a 50 Ω shunt (JP1) is applied; in the ranges 0...10 VDC, a 500 Ω shunt (JP2) is applied.

DIGITAL OUTPUT(S)

The action on the outputs can be inverted, and the hysteresis can be set acc. to your specifications.

At power up, shifts on the outputs can be delayed for up to 999 s.

NPN and PNP outputs for external relay, electromechanical counter, PLC input, or equivalent load.

The outputs are current-limited by way of PTC resistors.

RELAY OUTPUTS

The PRecon 5223 can be delivered with 2 relay outputs that are programmed individually.

STATUS INDICATION

The 5223 is equipped with 5 front LEDs.

| | |
|---------------------------|---|
| f1 and f2 in: | Indicates an active input (non-active at NPN input). |
| Dig. out. 1 and 2: | Indicates active output. |
| Error: | Programmable by use of PRreset to indicate sensor errors. |

ELECTRICAL SPECIFICATIONS

Specifications range..... -20°C to +60°C

Common specifications:

| | |
|--------------------------------------|----------------------------------|
| Supply voltage | 19.2...300 VDC 21.6...253 VAC |
| Frequency | 50...60 Hz |
| Fuse..... | 400 mA T / 250 VAC |
| Internal consumption | 3 W |
| Max. consumption..... | 3.5 W |
| Isolation, test / operation..... | 3.75 kVAC / 250 VAC |
| Power up delay | 0...999 s |
| Warm-up time..... | 1 min. |
| Communications interface | Loop Link |
| Signal / noise ratio | Min. 60 dB |
| Response time, analogue..... | < 60 ms + period |
| Response time, digital output..... | < 50 ms + period |
| Signal dynamics, output | 16 bit |
| Calibration temperature | 20...28°C |
| Temperature coefficient..... | < ± 0.01% of span / °C |
| Linearity error | < ± 0.1% of span |
| Effect of supply voltage change..... | < 0.005% of span / VDC |

Auxiliary voltages:

| | |
|------------------------------------|--------------------------|
| NAMUR supply | 8.3 VDC ± 0.5 VDC / 8 mA |
| NAMUR supply EEx | 8.5 VDC ± 0.5 VDC / 8 mA |
| SO supply | 17 VDC / 20 mA |
| NPN / PNP supply..... | 17 VDC / 20 mA |
| Special supply (programmable)..... | 5...17 VDC / 20 mA |

EMC immunity influence

| |
|----------|
| < ± 0.5% |
|----------|

| | |
|-----------------------------|---------------------------------------|
| Max. wire size..... | 1 x 2,5 mm ² stranded wire |
| Screw terminal torque | 0.5 Nm |
| Air humidity..... | <95% RH (non cond.) |
| Dimensions (HxWxD) | 109 x 23.5 x 130 mm |
| DIN rail type..... | DIN 46277 |
| Protection degree..... | IP20 |
| Weight | 250 g |

Input:**General:**

| | |
|--|---|
| Measurement range..... | 0...20 kHz |
| Min. measurement range..... | 0.001 Hz |
| Max. offset | 90% of selected max. frequency |
| Min. pulse width (without filter)..... | 25 μ s |
| Min. period (without filter)..... | 50 μ s |
| Max. frequency (without filter) | 20 kHz |
| Min. pulse width (with filter)..... | 10 ms |
| Min. period (with filter)..... | 20 ms |
| Max. frequency (with filter)..... | 50 Hz |
| Programmable trig level..... | 0.025...6.5 V (nom.) 1...8 mA (nom.) |

NAMUR input acc. to DIN 19234:

| | |
|-----------------------|---------------|
| Trig-level LOW..... | ≤ 1.2 mA |
| Trig-level HIGH..... | ≥ 2.1 mA |
| Input impedance | 1000 Ω |

Sensor error detection (only for NAMUR):

| | |
|---------------------|---------------|
| Breakage | ≤ 0.1 mA |
| Short-circuit | ≥ 7.0 mA |
| Response time | ≥ 400 ms |

Tacho input:

| | |
|--------------------------|-----------------------|
| Trig-level LOW..... | ≤ -40 mV |
| Trig-level HIGH..... | ≥ 40 mV |
| Input impedance | ≥ 100 k Ω |
| Max. input voltage | 80 VAC pp |

NPN / PNP input:

| | |
|---------------------------------------|----------------------|
| Trig-level LOW..... | ≤ 4.0 V |
| Trig-level HIGH..... | ≥ 7.0 V |
| Input impedance, standard..... | 3.48 k Ω |
| Input impedance, special version..... | 3.48...12 k Ω |

2-phase encoder:

| | |
|--|--------|
| Min. pulse width (without filter)..... | 1 ms |
| Min. period (without filter)..... | 2 ms |
| Max. frequency (without filter)..... | 500 Hz |

TTL input:

| | |
|-----------------------|-----------|
| Trig-level LOW | ≤ 0.8 VDC |
| Trig-level HIGH | ≥ 2.0 VDC |
| Input impedance | ≥ 100 kΩ |

SO input acc. to DIN 43 864:

| | |
|-----------------------|----------|
| Trig-level LOW | ≤ 2.2 mA |
| Trig-level HIGH | ≥ 9.0 mA |
| Input impedance | 800 Ω |

Analogue output:**Current output:**

| | |
|-------------------------|----------------------------|
| Signal range | 0...20 mA |
| Min. signal range | 5 mA |
| Max. offset | 50% of selected max. value |
| Updating time | 20 ms |
| Load (max.) | 20 mA / 600 Ω / 12 VDC |
| Load stability | < ± 0.01% of span / 100 Ω |
| Current limit | ≤ 23 mA |

Voltage output through internal shunt:

| | |
|------------------------|----------------------------|
| Signal range | 0...10 VDC |
| Min. signal span | 250 mV |
| Max. offset | 50% of selected max. value |
| Load (min.) | 500 kΩ |

Active outputs (NPN / PNP):

| | |
|--------------------------------|--------|
| I _{max.} source | 10 mA |
| I _{max.} sink | 130 mA |
| V _{max.} | 28 VDC |

f/f converter output:

| | |
|------------------------|-------------|
| Signal range | 0...1000 Hz |
| Min. pulse width | 500 μs |
| Max. pulse width | 999 ms |
| Max. duty cycle | 50% |

Frequency generator:

| | |
|----------------------|--------|
| Min. period | 50 μs |
| Max. frequency | 20 kHz |
| Duty cycle | 50% |

Relay output:

| | |
|-------------------------------------|----------|
| Frequency max..... | 20 Hz |
| V _{max} | 250 VRMS |
| I _{max} | 2 A / AC |
| Max. AC power | 500 VA |
| Max. AC power Ex version 5223B..... | 100 VA |
| Max. load at 24 VDC..... | 1 A. |

EEx / I.S. approval -5223B:

| | |
|--------------------------|---|
| KEMA 04ATEX1001..... |  II (1) GD |
| | [EEx ia] IIC |
| Applicable in zone | 0, 1, 2, 20, 21 or 22 |

Ex / I.S. data:

| | |
|----------------------------|------------|
| Terminal 31, 33 | |
| U _m | : 250 V |
| Terminal 42, 43 and 52, 53 | |
| U ₀ | : 10.6 VDC |
| I ₀ | : 13.8 mA |
| P ₀ | : 38 mW |
| L ₀ | : 160 mH |
| C ₀ | : 1.9 µF |

GOST R approval:

VNIIM & VNIIFTRI, Cert. no. See www.prelectronics.com

Observed authority requirements:

| | |
|-----------------------|------------------------------------|
| EMC 2004/108/EC | EN 61326-1 |
| LVD 2006/95/EC..... | EN 61010-1 |
| PELV/SELV | IEC 364-4-41 and EN 60742 |
| ATEX 94/9/EC..... | EN 50014, EN 50020 and EN 50284 |

Standard:

Of span = Of the presently selected range

BLOCK DIAGRAM 5223A

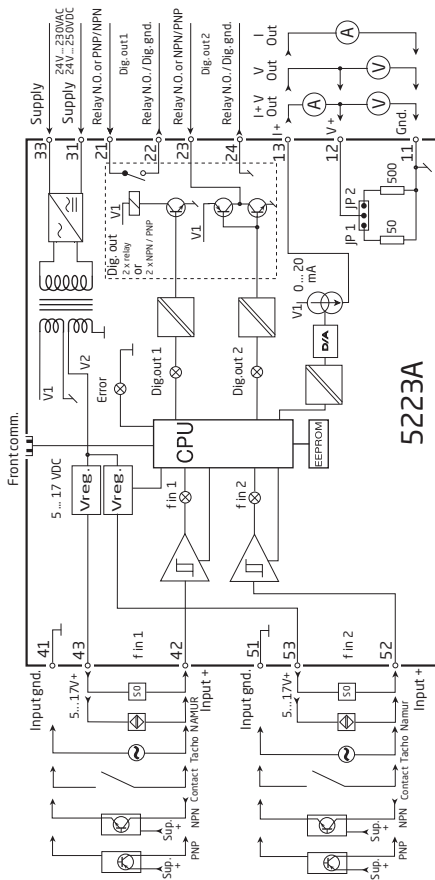

5223A

BLOCK DIAGRAM 5223B

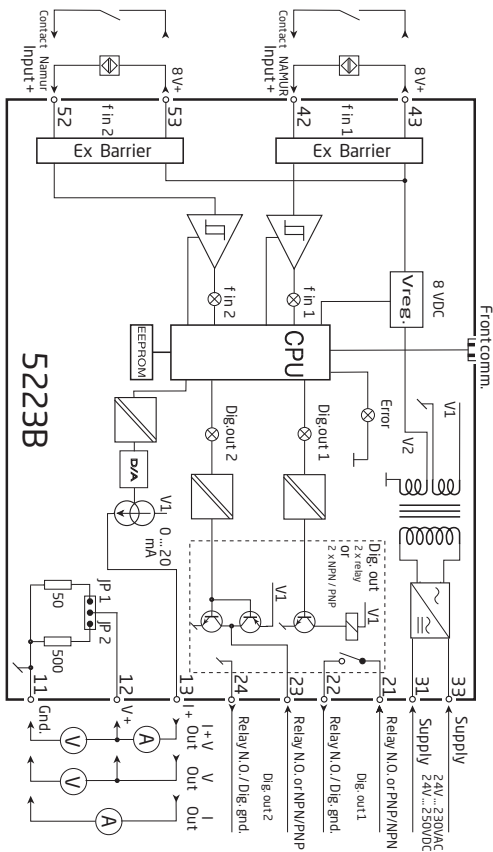



Displays

Programmable displays with a wide selection of inputs and outputs for display of temperature, volume and weight, etc. Feature linearization, scaling, and difference measurement functions for programming via PReset software.



Ex interfaces

Interfaces for analog and digital signals as well as HART® signals between sensors / I/P converters / frequency signals and control systems in Ex zone 0, 1 & 2 and for some devices in zone 20, 21 & 22.



Isolation

Galvanic isolators for analog and digital signals as well as HART® signals. A wide product range with both loop-powered and universal isolators featuring linearization, inversion, and scaling of output signals.



Temperature























A wide selection of transmitters for DIN form B mounting and DIN rail devices with analog and digital bus communication ranging from application-specific to universal transmitters.



Universal

PC or front programmable devices with universal options for input, output and supply. This range offers a number of advanced features such as process calibration, linearization and auto-diagnosis.



- 
 www.preelectronics.fr
 sales-fr@preelectronics.com
- 
 www.preelectronics.de
 sales-de@preelectronics.com
- 
 www.preelectronics.es
 sales-es@preelectronics.com
- 
 www.preelectronics.it
 sales-it@preelectronics.com
- 
 www.preelectronics.se
 sales-se@preelectronics.com
- 
 www.preelectronics.co.uk
 sales-uk@preelectronics.com
- 
 www.preelectronics.com
 sales-us@preelectronics.com
- 
 www.preelectronics.cn
 sales-cn@preelectronics.com

Head office

Denmark
 PR electronics A/S
 Lerbakken 10
 DK-8410 Rønede

www.preelectronics.com
sales-dk@preelectronics.com
 tel. +45 86 37 26 77
 fax +45 86 37 30 85



QUALITY SYSTEM AND ENVIRONMENTAL MANAGEMENT SYSTEM
 DS/EN ISO 9001
 DS/EN ISO 14001

